



RDG400KN



RDG405KN

Room thermostats with KNX communications

RDG400KN RDG405KN

For VAV heating and cooling systems
For room temperature and indoor air quality control

- **KNX bus communications (S- and LTE-Mode)**
- **Backlit display**
- **PI/P control**
- **Output for VAV box/air damper: DC 0...10 V/3-position/KNX LTE-Mode**
- **Output for heating/cooling coil: On/Off, PWM or 3-position/DC 0...10 V**
- **Output signal inversion as an option (DC 0...10 V → DC 10...0 V)**
- **2 multifunctional inputs for keycard contact, external sensor, etc.**
- **1 DC 0...10 V input for external sensor or feedback of air damper position**
- **Operating modes: Comfort, Economy and Protection**
- **Control depending on room or return air temperature**
- **Optimized operation of supply air fan: Input DC 0...10 V for feedback of air damper position**
- **Automatic or manual heating/cooling changeover**
- **Minimum and maximum limitation of room temperature setpoint**
- **Minimum and maximum limitation of air flow signal**
- **Adjustable commissioning and control parameters**
- **Commissioning with Synco ACS790, ETS or via local HMI**
- **Integration into Synco; integration into Desigo via group addressing (ETS) or individual addressing**
- **Integration into third-party system via group addressing (ETS)**
- **Indoor air quality (IAQ) control loop with external CO₂ sensor (DC 0...10 V or KNX LTE- and S-Mode) (RDG405KN)**
- **Operating voltage AC 24 V**
- **Interworking with KNX CO₂/temperature sensors (LTE- and S-Mode)**

The RDG40..KN room thermostats are designed for the following types of system:

VAV systems via On/Off or modulating control outputs or KNX LTE-Mode:

- Single-duct system
- Single-duct system with electric heater
- Single-duct system and radiator/floor heating
- Single-duct system with heating/cooling coil

The room thermostats are delivered with a fixed set of applications.

The required application is selected and activated during commissioning using one of the following tools:

- Synco ACS
- ETS
- Local DIP switch and HMI

Functions

- Room temperature control via built-in temperature sensor or external room temperature/return air temperature sensor
- Indoor air quality control via external CO₂ sensor (DC 0...10 V, KNX LTE- or S-Mode) (RDG405KN)
- Changeover between heating and cooling mode (automatically via local sensor or bus, or manually)
- Selection of applications via DIP switches or commissioning tool (ACS790, ETS)
- Parameter download with commissioning tool (ACS, ETS)
- Selection of operating mode via operating mode button on the thermostat
- Temporary Comfort mode extension
- Minimum and maximum limitation of room temperature setpoint
- Minimum and maximum limitation of air flow signal (selectable via ETS)
- External CO₂ sensor, DC 0...10 V; 0...2000 ppm (RDG405KN)
- External CO₂ sensor, KNX; 0...5000 ppm (RDG405KN)
- Button lock (automatic or manual)
- 2 multifunctional inputs, freely selectable for:
 - Operating mode switchover contact (keycard, window contact, etc.) (RDG400KN)
 - Window contact switches operating mode to Protection (RDG405KN)
 - Presence detector switches operating mode to Comfort (RDG405KN)
 - Changeover sensor for automatic heating/cooling mode
 - External room temperature or return air temperature sensor
 - Dewpoint sensor
 - Electric heater enable
 - Faults
 - Monitor input for temperature sensor or switch status
- 1 input DC 0...10 V for external sensor and feedback of air damper position
- Optimization of pressure control using ...
 - feedback of air damper position and current air flow value via KNX bus,
 - or feedback of air damper position via DC 0...10 V input
- Floor heating temperature limit
- Reloading factory settings for commissioning and control parameters
- KNX bus (terminals CE+ and CE-) for communication with Synco or KNX compatible devices
- Display of outside temperature or time of day via KNX bus

- Display of current room temperature or setpoint in °C and/or °F
- Display of CO₂ external sensor value in ppm or with symbols (+++, ++-, +--)
(RDG405KN)
- Time scheduling and central control of setpoints via KNX bus
- RMB7../RMU7.. controller (signal exchange over KNX) using ...
 - the air demand signal of the thermostat to optimize the supply air temperature,
 - the energy demand signals of the heating/cooling equipment to optimize the supply of energy,
 - the feedback of the air damper position (DC 0...10 V or KNX) to optimize operation of the supply air fan

Applications

The thermostat supports the following applications, which can be configured using the DIP switches at the rear of the unit or a commissioning tool.
DIP switches 1...5 need to be set to OFF (remote configuration, factory setting) to select an application via commissioning tool.

Application	DIP switches
Remote configuration Via commissioning tool (factory setting) <ul style="list-style-type: none"> • Synco ACS • ETS 	
Single-duct <ul style="list-style-type: none"> • DC 0...10 V damper actuator (P47 = 0) • 3-position damper actuator (P47 = 1) • VAV compact controller with KNX LTE-Mode 	
Single-duct with electric heater <ul style="list-style-type: none"> • DC 0...10 V damper actuator and On/Off, PWM or 3-position electric heater (P47 = 0) • 3-position damper actuator and DC 0...10 V electric heater (P47 = 1) • VAV compact controller with KNX LTE-Mode and electric heater 	
Single-duct and radiator/floor heating <ul style="list-style-type: none"> • DC 0...10 V damper actuator and On/Off, PWM or 3-position radiator (P47 = 0) • 3-position damper actuator and DC 0...10 V radiator (P47 = 1) • VAV compact controller with KNX LTE-Mode and radiator 	

Single-duct heating and cooling coil

- DC 0...10 V damper actuator and On/Off, PWM or 3-position heating and cooling (P47 = 0)
- 3-position damper actuator and DC 0...10 V heating and cooling (P47 = 1)
- VAV compact controller with KNX LTE-Mode and heating/cooling coil

- Note
- P47 is used to change air damper output from DC 0...10 V (factory setting) to 3-position
 - P46 is used to change valve output from On/Off (factory setting) to PWM
 - DIP switch 4 is used to change output of Y10 from DC 0...10 V to DC 10...0 V
 - DIP switch 5 is used to change valve output from On/Off to 3-position

Type summary

Product No.	Features							
	Operating voltage	Number of control outputs				VAV control via KNX LTE-Mode	IAQ	Backlit LCD
		On/Off	PWM	3-pos.	DC 0...10 V			
RDG400KN	AC 24 V	1 ¹⁾	1 ¹⁾	1 ¹⁾	1	✓	---	✓
RDG405KN	AC 24 V	1 ¹⁾	1 ¹⁾	1 ¹⁾	1	✓	✓	✓





¹⁾ Selectable: On/Off, PWM or 3-position (triac outputs)















Ordering











Product No.	Stock No.	Description
RDG400KN	S55770-T165	Room thermostat
RDG405KN	S55770-T346	Room thermostat

Order valve actuators separately.

Equipment combinations

Sensors	Type of unit	Product No.	Data Sheet
	Cable temperature sensor	 QAH11.1	1840
	Room temperature sensor	 QAA32	1747
	Condensation monitor	 QXA21..	A6V10741072
	Flush-mount KNX room sensor (base and front module)	 AQR2576N.. AQR2532NNW AQR2530NNW AQR2532NNW AQR2535NNWQ	1411

	Wall-mount KNX sensor		QMX3.P30 QMX3.P70	1602
Valve actuators DC 0...10 V	Electric actuator, DC 0...10 V (for radiator valves)		SSA61..	4893
	Electric actuator, DC 0...10 V (for 2- and 3-port valves/V..P45)		SSC61..	4895
	Electric actuator, DC 0...10 V (for small valves 2.5 mm V..P47)		SSP61..	4864
	Electric actuator, DC 0...10 V (for small valves 5.5 mm V..P45)		SSB61..	4891
	Electric actuator, DC 0...10 V (for CombiValves VPI46)		SSA61..	4893
	Electromotoric actuator, DC 0...10 V (for valves 5.5 mm)		SAS61..	4581
	Thermal actuator, DC 0...10 V (for small valves and radiator valves)		STP63	4884
Damper actuators DC 0...10 V and 3-position, VAV compact controllers	Damper actuator DC 0...10 V, damper actuator 3-position		GQD161.. GQD131..	4605
			GDB161.. GDB131.. GLB161.. GLB131..	4634
			GMA161.. GMA131..	4614
			GEB161.. GEB131..	4621
			GCA161.. GCA131..	4613
			GBB161.. GBB131.. GIB161.. GIB131..	4626
	VAV compact controller		GDB181.1E/3 GLB181.1E/3	3544

VAV compact controllers KNX LTE-Mode	VAV compact controller for KNX LTE-Mode		GDB181.1E/KN	3547
			GLB181.1E/KN	
On/Off valve actuators AC 24 V	Electromotoric On/Off valve and actuator (only available in AP, UAE, SA and IN)		MVI../MXI..	4867
	Electromotoric On/Off actuator		SFA71..	4863
On/Off/PWM valve actuators AC 24 V*	Thermal actuator (for radiator valves)		STA73..	4884
	Thermal actuator (for small valves 2.5 mm)		STP73..	4884
3-position valve actuators AC 24 V	Electric actuator, 3-position (for radiator valves)		SSA81..	4893
	Electric actuator, 3-position (for small valves 2.5 mm V..P47)		SSP81..	4864
	Electric actuator, 3-position (for small valves 5.5 mm V..P45)		SSB81..	4891
	Electric actuator, 3-position (for CombiValves VPI46)		SSA81..	4893
	Electromotoric actuator, 3-position (for valves 5.5 mm)		SAS81..	4581

* With PWM control, it is not possible to ensure exact parallel running of more than one thermal actuator. If several actuators are controlled by the same room thermostat, preference should be given to motorized actuators with On/Off or 3-position control

Note For more information about parallel operation and the maximum number of actuators that can be used, refer to the Data Sheets of the selected type of actuator and the following listing:

Maximum number of actuators in parallel operation in connection with RDG400KN and RDG405KN:

- 6 actuators S..81 (3-position)
- 4 actuators ST..73 (On/Off)
- 4 actuators SFA.., MVI.., MXI.. (On/Off)
- 10 damper actuators G..16.. DC
- 6 damper actuators G..13.. (3-position)

Accessories

Description	Product No./stock No.	Data Sheet ^{*)}
KNX power supply unit 160 mA (Siemens BT LV)	5WG1 125-1AB02	--
KNX power supply unit 320 mA (Siemens BT LV)	5WG1 125-1AB12	--
KNX power supply unit 640 mA (Siemens BT LV)	5WG1 125-1AB22	--

*) Documents can be downloaded from <http://siemens.com/bt/download>

Mechanical design

The room thermostat consists of 2 parts:

- Plastic housing with electronics, operating elements and room temp. sensor
- Mounting plate with screw terminals

The housing engages in the mounting plate and is secured with 2 screws.

Operation and settings

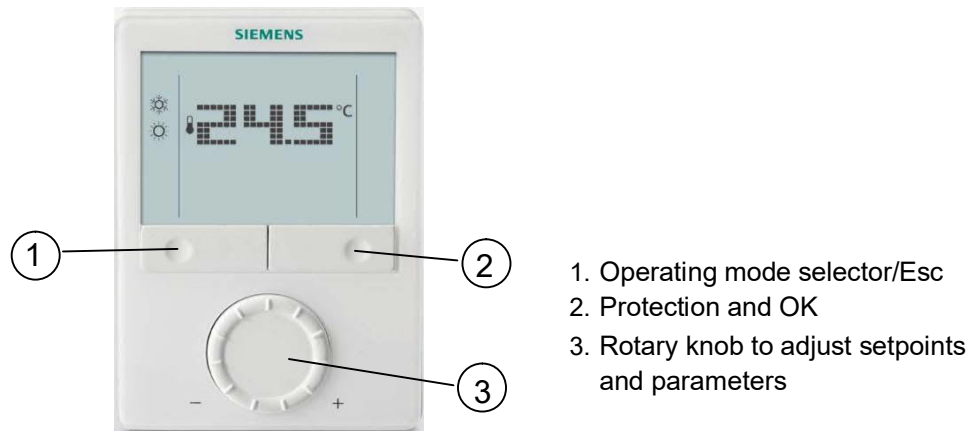

Display

RDG400KN
RDG405KN

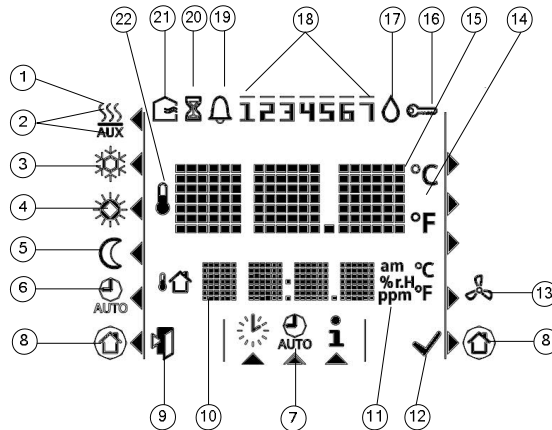

#	Symbol	Description	#	Symbol	Description
1		Heating mode	13		Primary fan active (only supported with Synco700 primary controller)
2		Heating mode, electric heater active	14		Degrees Celsius Degrees Fahrenheit
3		Cooling mode	15		Digits for room temperature and setpoint display
4		Comfort	16		Button lock active
5		Economy	17		Condensation in the room (dewpoint sensor active)
6		Auto Timer mode according to schedule (via KNX)	18		Weekday 1...7 from KNX bus 1 = Monday/7 = Sunday
7					
8		Protection mode	19		Fault
9		Escape	20		Temporary timer function; visible when operating mode is temporarily extended (extended presence or absence)
10		Additional user information, like outside temperature or time of day from KNX bus; selectable via parameters	21		Fresh air (RDG405KN)
11		am and pm: Real time clock in either 24-hour or 12-hour (am/pm) mode ppm: CO ₂ external sensor value (RDG405KN)	22		Indicates that room temperature is displayed
12		Confirmation of parameters			

See "Reference documentation" below for information on how to engineer the KNX bus (topology, bus repeaters, etc.) and how to select and size connecting cables for power supply and field devices.

Mounting and installation

Do not mount on a wall in niches or bookshelves, behind curtains, above or near heat sources, or exposed to direct solar radiation. Mount about 1.5 m above the floor.

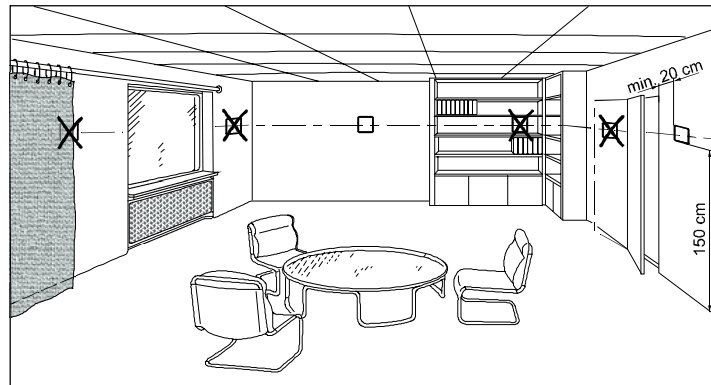

Mounting



- Mount the room thermostat on a clean, dry indoor place without direct air flow from a heating/cooling device, and not exposed to drip or splash water

Wiring

See Mounting Instructions M3192 (RDG400KN) or A6V10733804 (RDG405KN) enclosed with the thermostat.



- Comply with local regulations to wire, fuse and earth the thermostat
- Power supply line must have a circuit breaker with a rated current of no more than 10 A



- Isolate the cables of inputs X1-M, U1-G0 and D1-GND for 230 V if the conduit box carries AC 230 V mains voltage
- Inputs X1-M or D1-GND: Several switches (e.g. summer/winter switch) may be connected in parallel. Consider overall maximum contact sensing current for switch rating



- Isolate the cables of KNX communication input CE+/CE- for 230 V if conduit box carries AC 230 V mains voltage



- Disconnect the unit from power supply before removing it from its mounting plate
- If a KNX bus power supply is connected to the line with communicating thermostats and a Synco controller, the internal KNX power supply of the Synco controller must be switched off

Commissioning notes

Applications

The room thermostats are delivered with a fixed set of applications.

Select and activate the required application during commissioning using one of the following tools:

- Local DIP switch and HMI
- Synco ACS
Version 5.11 or higher (for RDG400KN)
Version 10.03 or higher (for RDG405KN)
- ETS

Set the DIP switches before snapping the unit to its mounting plate, if you want to select an application via DIP switches.

All DIP switches must be set to OFF (remote configuration), if you want to select an application via commissioning tool.

After power is applied, the thermostat resets and all LCD segments flash, indicating that the reset was made correctly. After the reset, which takes about 3 seconds, the thermostat is ready for commissioning by qualified HVAC staff.

If all DIP switches are set to OFF, the display reads **NO APPL** to indicate that application commissioning via tool is required.

Note Each time the application is changed, the thermostat reloads the factory settings for all control parameters, except for KNX device and zone addresses!

Connect tool

For commissioning, connect the Synco ACS or ETS tool to the KNX bus cable at any point:

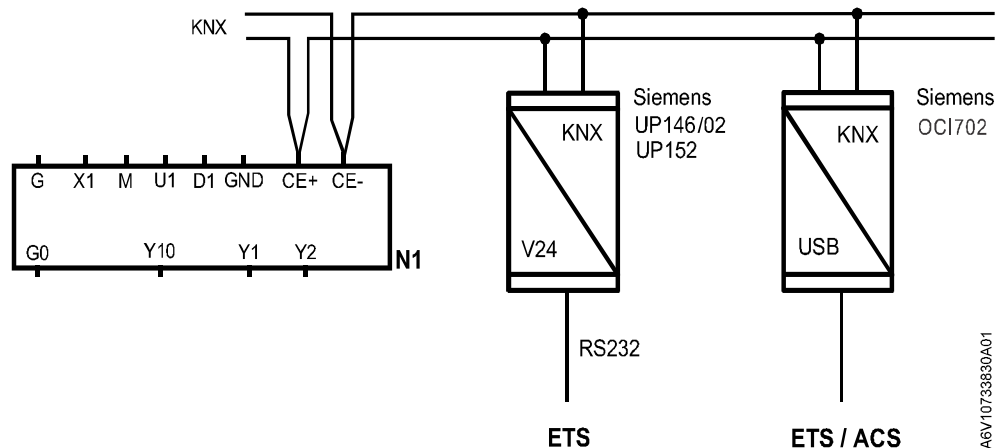

ACS and ETS3 require an interface:

- RS232 KNX interface (e.g. Siemens UP146/02, UP152)
- OCI702 USB-KNX interface

Note An external KNX bus power supply is required if an RDG.. is connected directly to a tool (ACS or ETS) via KNX interface.

Control parameters	<p>The thermostat's control parameters can be changed to ensure optimum performance of the entire system (see Basic Documentation P3192). The parameters can be adjusted using ...</p> <ul style="list-style-type: none"> – the local HMI – Synco ACS – ETS
Control sequence	<ul style="list-style-type: none"> • The control sequence may need to be set via P01 depending on the application. The factory setting is "Cooling only"
Calibrating the sensor	<ul style="list-style-type: none"> • Recalibrate the temperature sensor if the room temperature displayed on the thermostat does not match the room temperature measured (after min. 1 hour of operation). To do this, change P05
Setpoint and setpoint range limitation	<ul style="list-style-type: none"> • We recommend to review the setpoints and setpoint ranges (P08...P12) and to change them as needed to ensure maximum room comfort and to save energy
Programming mode	<p>The programming mode helps identify the thermostat in the KNX network during commissioning.</p> <p>Press the left and right buttons simultaneously for 6 seconds to activate programming mode, which is indicated on the display with PrOg. Programming mode remains active until identification of the thermostat is complete.</p>
Assigning the KNX device address	<p>Assign the device address (P81) via HMI, ACS or ETS.</p> <p>To deactivate communication, set the device address to 255 (no exchange of process data).</p>
Assigning the KNX group addresses	<p>Use ETS to assign the KNX group addresses of the RDG communication objects.</p>
KNX serial number	<p>Each device has a unique KNX serial number inside the plastic housing. An additional sticker with the same KNX serial number is enclosed in the packaging box. This sticker is intended for installers for documentation purposes.</p>



Disposal



The device is considered electrical and electronic equipment for disposal in terms of the applicable European Directive and may not be disposed of as domestic garbage.

- Dispose of the device through channels provided for this purpose.
- Comply with all local and currently applicable laws and regulations.

Technical data

 Power supply	Operating voltage	SELV AC 24 V \pm 20%
	Rated voltage	AC 24 V
	Frequency	50/60 Hz
	Power consumption	Max. 2 VA/1 W
	No internal fuse!	
	In all cases, external preliminary protection with a circuit breaker max. C 10 A is required	
	Control output Y10-G0	DC 0...10 V
	Resolution	39 mV
Outputs	Current	Max. \pm 1 mA
	Control output Y1, Y2-G	AC 24 V
	Rating	Max. 1 A
	Power limitation	3 A fast microfuse (cannot be exchanged)
Inputs	Multifunctional inputs	
	X1-M	
	Temperature sensor input	
	Type	QAH11.1 (NTC)
	Temperature range	0...49 °C (32...120°F)
	Cable length	Max. 80 m
	Digital input	
	Operating action	Selectable (NO/NC)
	Contact sensing	DC 0...5 V, max. 5 mA
	Parallel connection of several thermostats for one switch	Max. 20 thermostats per switch. Do not mix with D1!
	U1-G0	
	Input for actual damper position feedback	DC 0...10 V, max. 0.3 mA
	damper position 0% (fully closed)	0...100%
	100% (fully open)	
Input for external CO ₂ sensor (RDG405KN)	DC 0...10 V, max. 0.3 mA	
	0... 2000 ppm	
D1-GND		
Operating action	Selectable (NO/NC)	
Contact sensing	SELV DC 6...15 V, 3...6 mA	
Parallel connection of several thermostats for one switch	Max. 20 thermostats per switch. Do not mix with X1!	
Function of inputs		
External temperature sensor, heating/cooling changeover sensor, operating mode switchover contact, dewpoint monitor contact, enable electric heater contact, fault contact, monitoring input	Selectable X1: P38 D1: P42	
KNX bus	Interface type	KNX, TP1-64 (galvanically separated)
	Bus current	5 mA
	Bus topology:	Refer to KNX Manual (see reference documentation listed below)

Operational data	Switching differential, adjustable	
	Heating mode	(P30) 2 K (0.5...6 K)
	Cooling mode	(P31) 1 K (0.5...6 K)
	Setpoint setting and setpoint range	
	Comfort	(P08) 21 °C (70 °F) (5...40 °C) (41...104 °F)
	Economy	(P11...P12) 15 °C (59 °F)/30 °C(86 °F) (OFF, 5...40 °C)
	Protection	(P65...P66) 8 °C (64 °F)/OFF (OFF, 5...40 °C)
	Multifunctional inputs X1, D1	
	Input X1 default value	(P38) 1 (ext. temperature sensor, room or return air)
	Input D1 default value	(P42) 3 (operating mode switchover)
Environmental conditions	Built-in room temperature sensor	
	Measuring range	0...49 °C (32...120 °F)
	Accuracy at 25 °C (after calibration via P05)	< ± 0.5 K
	Temperature calibration range	± 3.0 K
	Settings and display resolution	
	Setpoints	0.5 °C (1 °F)
	Current temperature value displayed	0.5 °C (1 °F)
	Operation	
	Climatic conditions	IEC 60721-3-3 Class 3K5
	Temperature	0...50 °C (32...122 °F)
Humidity	<95% r.h.	
Standards and directives	Transport	
	Climatic conditions	IEC 60721-3-2 Class 2K3
	Temperature	-25...60 °C (-77...140 °F)
	Humidity	<95% r.h.
	Mechanical conditions	Class 2M2
	Storage	
	Climatic conditions	IEC 60721-3-1 Class 1K3
	Temperature	-25...60 °C (-77...140 °F)
	Humidity	<95% r.h.
	EU Conformity (CE)	
RCM conformity		CE1T3192en C1
Safety class		III as per EN 60730-1
Pollution class		Normal
Degree of protection of housing		IP30 as per EN 60529
Environmental compatibility	The product's Environmental Declaration CE1E3181 or A6V10733828 ^{*)} contains data on environmentally compatible product design and assessments (RoHS compliance, materials composition, packaging, environmental benefit, disposal).	
General	Connection terminals	
	Solid wires or stranded wires with ferrules 1 x 0.4...2.5 mm ² or 2 x 0.4...1.5 mm ²	
	Note: For sensors on inputs X1, U1 or D1, the cable length is max. 80 m	
	Housing front color	RAL 9003 white
	Weight without/with packaging	0.237 kg/0.360 kg

*) Documents can be downloaded from <http://siemens.com/bt/download>

Reference documentation^{*)} Handbook for Home and Building Control – Basic Principles (www.knx.org/uk/news-press/publications/publications/)

- Synco CE1P3127 Communication via the KNX bus for Synco 700, 900, and RXB/RXL
Basic Documentation
- DESIGO CM1Y9775 DESIGO RXB integration – S-Mode
CM1Y9776 DESIGO RXB/RXL integration – individual addressing
CM1Y9777 Third-party integration
CM1Y9778 Synco integration
CM1Y9779 Working with ETS

*) Documents can be downloaded from <http://siemens.com/bt/download>

Connection terminals

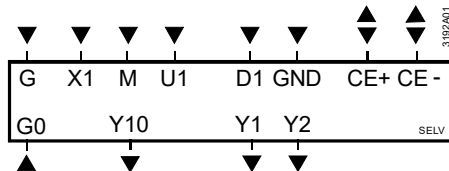

- G-G0 Operating voltage AC 24 V
- Y10-G0 Control output for DC 0...10 V actuator
- Y1-G, Y2-G Control outputs for On/Off, PWM or 3-position actuators
- X1-M Multifunctional input for temperature sensor (e.g. QAH11.1) or potential-free switch. Factory setting: External temperature sensor (function can be selected via P38)
- M Measuring neutral for sensors and switches
- U1-G0 DC 0...10 V input for current damper position
DC 0...10 V input for CO₂ sensor (0...2000 ppm) (RDG405KN)
(Note: G0 is the measuring neutral for U1!)
- D1-GND Multifunctional input for potential-free switch. Factory setting: Operating mode switchover contact (function can be selected via P42)
- CE+ KNX data +
- CE- KNX data –

Connection diagrams

Application

Single-duct

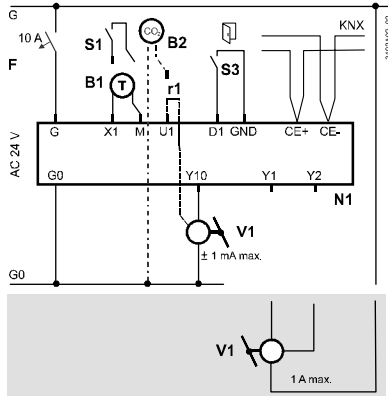

KNX V1

Single-duct with electric heater, radiator or heating/cooling valve

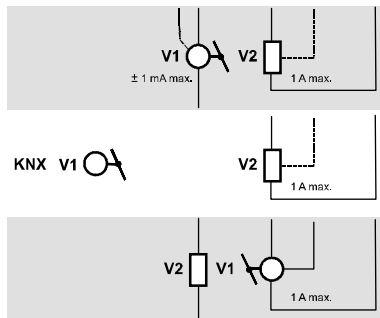

KNX V1

KNX V1

- N1 Room thermostat RDG400KN, RDG405KN
- V1 Damper actuator or VAV compact controller: DC 0...10 V or 3-position, VAV compact controller KNX
- V2 Electric heater, radiator or heating/cooling valve: DC 0...10 V, On/Off, PWM or 3-position
- S1 Switch (keycard, window contact, etc.)
- U1 DC 0...10 V input, feedback of current air damper position
DC 0...10 V input for CO₂ sensor (0...2000 ppm) (RDG405KN)
- S3 Switch at SELV input (keycard, window contact)
- B1 Temperature sensor (return air temperature, external room temperature, changeover sensor, etc.)
- B2 CO₂ sensor (0...2000 ppm) (RDG405KN)
- CE+ KNX data +
- CE- KNX data -

Dimensions

Dimensions in mm

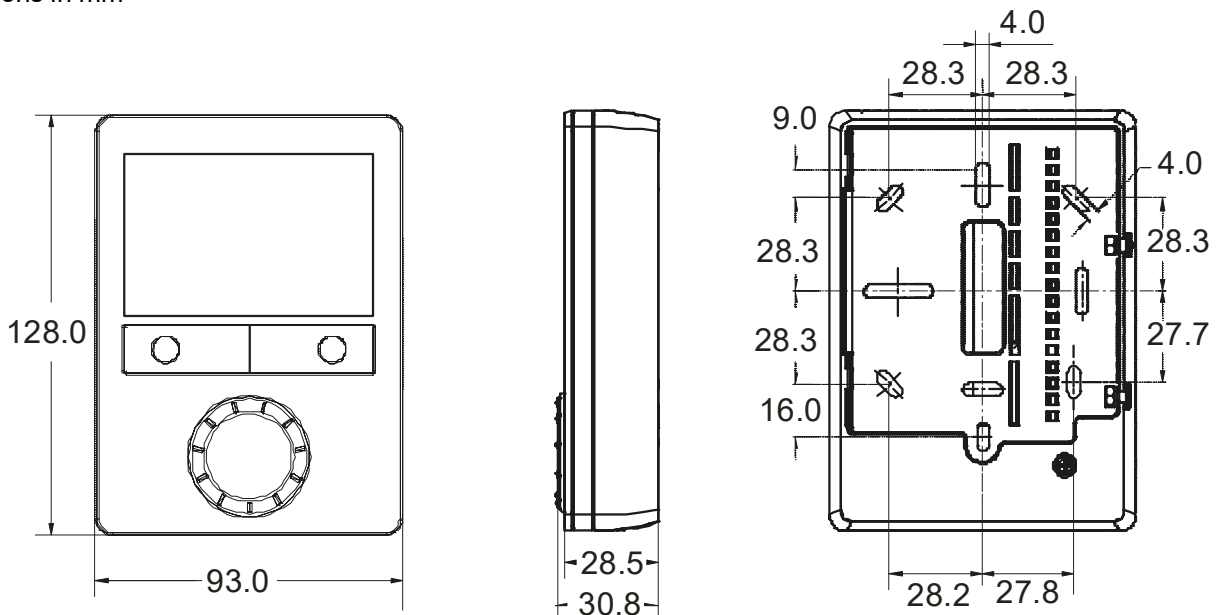

Issued by
Siemens Switzerland Ltd
Smart Infrastructure
Global Headquarters
Theilerstrasse 1a
CH-6300 Zug
Tel. +41 58 724 2424
www.siemens.com/buildingtechnologies

© Siemens Switzerland Ltd, 2010 - 2019
Technical specifications and availability subject to change without notice.