

Communicative damper actuator for adjusting dampers in technical building installations

- Air damper size up to approx. 2 m<sup>2</sup>
- Torque motor 10 Nm
- Nominal voltage AC/DC 24 V
- Control modulating, communicative, hybrid
- Conversion of sensor signals
- Communication via BACnet MS/TP, Modbus RTU, Belimo-MP-Bus or conventional control

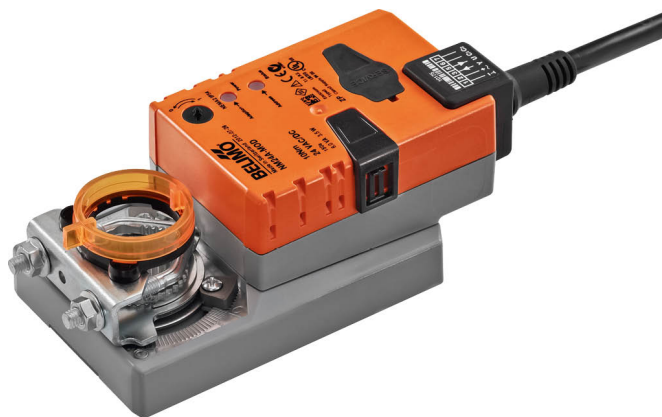

Technical data

<b>Electrical data</b>	Nominal voltage	AC/DC 24 V
	Nominal voltage frequency	50/60 Hz
	Nominal voltage range	AC 19.2...28.8 V / DC 21.6...28.8 V
	Power consumption in operation	3.5 W
	Power consumption in rest position	1.4 W
	Power consumption for wire sizing	6 VA
	Connection supply / control	Cable 1 m, 6 x 0.75 mm <sup>2</sup>
<b>Functional data</b>	Torque motor	10 Nm
	Torque variable	25%, 50%, 75% reduced
	Communicative control	BACnet MS/TP Modbus RTU (default setting) MP-Bus
	Operating range Y	2...10 V
	Operating range Y variable	0.5...10 V
	Position feedback U	2...10 V
	Position feedback U note	Max. 1 mA
	Position feedback U variable	Start point 0.5...8 V End point 2...10 V
	Position accuracy	±5%
	Direction of motion motor	selectable with switch 0/1
	Direction of motion note	Y = 0%: At switch position 0 (ccw rotation) / 1 (cw rotation)
	Direction of motion variable	electronically reversible
	Manual override	with push-button, can be locked
	Angle of rotation	Max. 95°
	Angle of rotation note	can be limited on both sides with adjustable mechanical end stops
	Running time motor	150 s / 90°
	Running time motor variable	43...173 s
	Adaptation setting range	manual
	Adaptation setting range variable	No action Adaptation when switched on Adaptation after pushing the gear disengagement button
	Override control	MAX (maximum position) = 100% MIN (minimum position) = 0% ZS (intermediate position, AC only) = 50%
Override control, controllable via bus communication	MAX (maximum position) = 100% MIN (minimum position) = 0% ZS (intermediate position) = 50%	

<b>Functional data</b>	Override control variable	MAX = (MIN + 32%)...100% MIN = 0%...(MAX - 32%) ZS = MIN...MAX
	Sound power level, motor	35 dB(A)
	Mechanical interface	Universal shaft clamp 8...26.7 mm
	Position indication	Mechanically, pluggable
<b>Safety data</b>	Protection class IEC/EN	III, Safety Extra-Low Voltage (SELV)
	Power source UL	Class 2 Supply
	Degree of protection IEC/EN	IP54
	Degree of protection NEMA/UL	NEMA 2
	Enclosure	UL Enclosure Type 2
	EMC	CE according to 2014/30/EU
	Certification IEC/EN	IEC/EN 60730-1 and IEC/EN 60730-2-14
	Certification UL	cULus according to UL60730-1A, UL60730-2-14 and CAN/CSA E60730-1 The UL marking on the actuator depends on the production site, the device is UL-compliant in any case
	Mode of operation	Type 1
	Rated impulse voltage supply / control	0.8 kV
	Pollution degree	3
	Ambient temperature	-30...50°C
	Storage temperature	-40...80°C
	Ambient humidity	Max. 95% RH, non-condensing
	Servicing	maintenance-free
<b>Weight</b>	Weight	0.93 kg

### Safety notes



- The device must not be used outside the specified field of application, especially not in aircraft or in any other airborne means of transport.
- Outdoor application: only possible in case that no (sea) water, snow, ice, insolation or aggressive gases interfere directly with the device and that it is ensured that the ambient conditions remain within the thresholds according to the data sheet at any time.
- Only authorised specialists may carry out installation. All applicable legal or institutional installation regulations must be complied during installation.
- The device may only be opened at the manufacturer's site. It does not contain any parts that can be replaced or repaired by the user.
- Cables must not be removed from the device.
- To calculate the torque required, the specifications supplied by the damper manufacturers concerning the cross-section, the design, the installation situation and the ventilation conditions must be observed.
- The device contains electrical and electronic components and must not be disposed of as household refuse. All locally valid regulations and requirements must be observed.

### Product features

<b>Mode of operation</b>	The actuator is fitted with an integrated interface for BACnet MS/TP, Modbus RTU and MP-Bus. It receives the digital positioning signal from the control system and returns the current status.
<b>Converter for sensors</b>	Connection option for a sensor (passive, active or with switching contact). In this way, the analogue sensor signal can be easily digitised and transferred to the bus systems : BACnet, Modbus or MP-Bus.

- Parametrisable actuators** The factory settings cover the most common applications. Single parameters can be modified with the Belimo Service Tools MFT-P or ZTH EU.  
The communication parameters of the bus systems (address, baud rate etc.) are set with the ZTH EU. Pressing the "Address" button on the actuator while connecting the supply voltage, resets the communication parameters to the factory setting.  
Quick addressing: The BACnet and Modbus address can alternatively be set using the buttons on the actuator and selecting 1...16. The value selected is added to the «Basic address» parameter and results in the effective BACnet and Modbus address.
- Combination analogue - communicative (hybrid mode)** With conventional control by means of an analogue positioning signal, BACnet or Modbus can be used for the communicative position feedback
- Simple direct mounting** Simple direct mounting on the damper shaft with a universal shaft clamp, supplied with an anti-rotation device to prevent the actuator from rotating.
- Manual override** Manual override with push-button possible (the gear is disengaged for as long as the button is pressed or remains locked).
- Adjustable angle of rotation** Adjustable angle of rotation with mechanical end stops.
- High functional reliability** The actuator is overload protected, requires no limit switches and automatically stops when the end stop is reached.
- Home position** The first time the supply voltage is switched on, i.e. at the time of commissioning, the actuator carries out a synchronisation. The synchronisation is in the home position (0%).  
The actuator then moves into the position defined by the positioning signal.

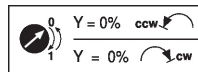

- Adaptation and synchronisation** An adaption can be triggered manually by pressing the "Adaption" button or with the PC-Tool. Both mechanical end stops are detected during the adaption (entire setting range).  
Automatic synchronisation after pressing the gearbox disengagement button is configured. The synchronisation is in the home position (0%).  
The actuator then moves into the position defined by the positioning signal.  
A range of settings can be adapted using the PC-Tool (see MFT-P documentation)

**Accessories**

Electrical accessories	Description	Type
	Feedback potentiometer 10 kΩ add-on	P10000A
	Feedback potentiometer 1 kΩ add-on	P1000A
	Feedback potentiometer 140 Ω add-on	P140A
	Feedback potentiometer 200 Ω add-on	P200A
	Feedback potentiometer 2.8 kΩ add-on	P2800A
	Feedback potentiometer 5 kΩ add-on	P5000A
	Feedback potentiometer 500 Ω add-on	P500A
	Auxiliary switch 1 x SPDT add-on	S1A
	Auxiliary switch 2 x SPDT add-on	S2A

Mechanical accessories	Description	Type
	Angle of rotation limiter for K-NA and K-SA	20334-00001
	Actuator arm for standard shaft clamp (one-sided)	AH-25
	Shaft extension 240 mm Ø20 mm for damper shaft Ø 8...22.7 mm	AV8-25
	Shaft clamp one-sided, clamping range Ø8...26 mm with insert, Multipack 20 pcs.	K-ENMA
	Shaft clamp one-sided, clamping range Ø8...26 mm, Multipack 20 pcs.	K-ENSA
	Shaft clamp reversible, clamping range Ø8...20 mm	K-NA
	Ball joint suitable for damper crank arm KH8 / KH10	KG10A
	Ball joint suitable for damper crank arm KH8	KG8
	Damper crank arm Slot width 8.2 mm, clamping range Ø10...18 mm	KH8
	Anti-rotation mechanism 180 mm, Multipack 20 pcs.	Z-ARS180
	Base plate extension for NM..A to NM.., pcs.	Z-NMA
	Position indicator, Multipack 20 pcs.	Z-PI
	Form fit insert 10x10 mm, Multipack 20 pcs.	ZF10-NSA
	Form fit insert 12x12 mm, Multipack 20 pcs.	ZF12-NSA
	Form fit insert 15x15 mm, Multipack 20 pcs.	ZF15-NSA
	Form fit insert 16x16 mm, Multipack 20 pcs.	ZF16-NSA
	Form fit insert 8x8 mm, Multipack 20 pcs.	ZF8-NMA
	Mounting kit for linkage operation for flat installation	ZG-NMA
Service tools	Description	Type
	Adapter for Service-Tool ZTH	MFT-C
	Belimo PC-Tool, Software for adjustments and diagnostics	MFT-P
	Connection cable 5 m, A: RJ11 6/4 ZTH EU, B: 6-pin for connection to service socket	ZK1-GEN
	Connection cable 5 m, A: RJ11 6/4 ZTH EU, B: free wire end for connection to MP/PP terminal	ZK2-GEN
	Service Tool, with ZIP-USB function, for parametrisable and communicative Belimo actuators, VAV controller and HVAC performance devices	ZTH EU

## Electrical installation



**Supply from isolating transformer.**

The wiring of the line for BACnet MS/TP / Modbus RTU is to be carried out in accordance with applicable RS485 regulations.

**Modbus / BACnet: Supply and communication are not galvanically isolated. Connect earth signal of the devices with one another.**

### Wiring diagrams

BACnet MS/TP / Modbus RTU

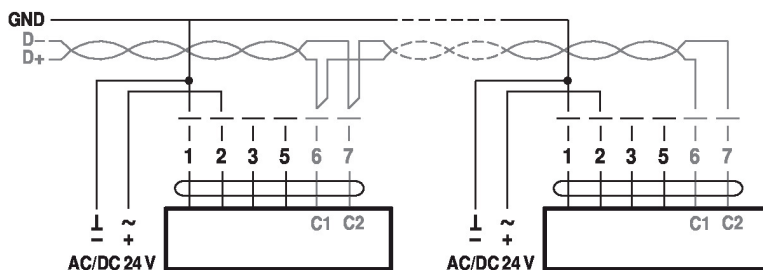

#### Cable colours:

- 1 = black
- 2 = red
- 3 = white
- 5 = orange
- 6 = pink
- 7 = grey

BACnet / Modbus signal

assignment:

C1 = D- = A

C2 = D+ = B

Connection with passive sensor, e.g. Pt1000, Ni1000, NTC

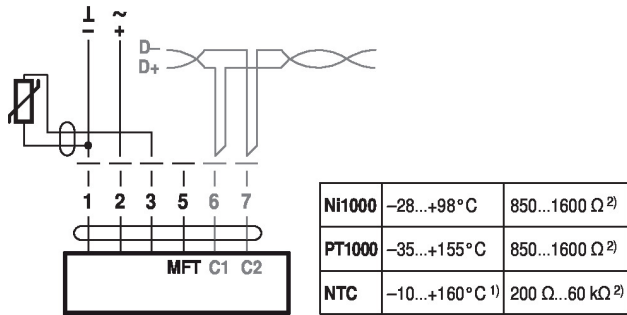

- 1) depending on type
  - 2) Resolution 1 Ohm
- Compensation of the measured value is recommended

Connection with active sensor, e.g. 0...10 V @ 0...50°C

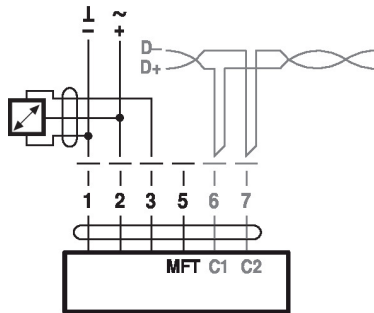

Possible voltage range:  
0...32 V (resolution 30 mV)

Connection with switching contact, e.g. Δp monitor

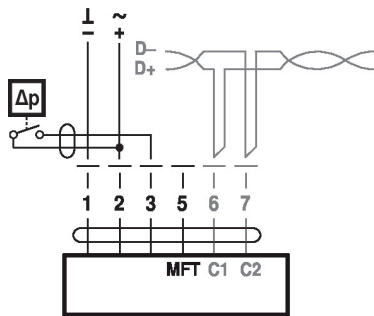

Requirements for switching contact:  
The switching contact must be able to accurately switch a current of 16 mA @ 24 V.

Modbus RTU / BACnet MS/TP with analogue setpoint (hybrid mode)

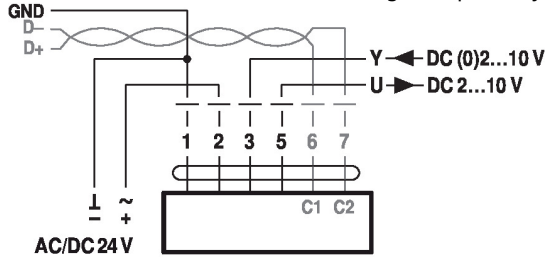

Operation on the MP-Bus

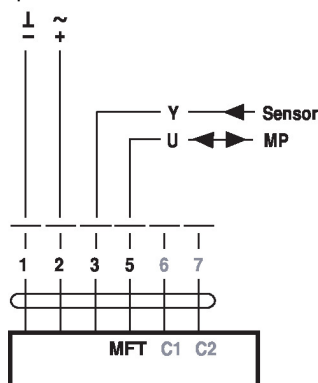

## Operating controls and indicators

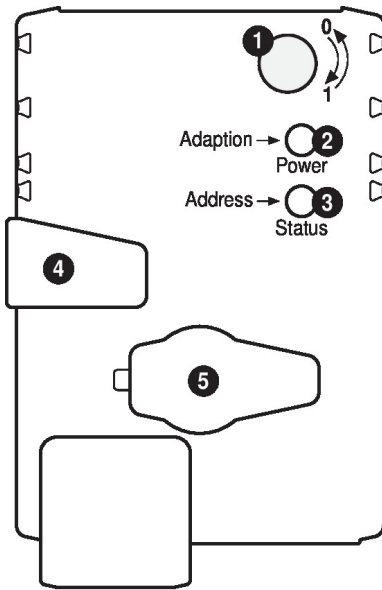
**1 Direction of rotation switch**

Switch over: Direction of rotation changes

**2 Push-button and LED display green**

Off: No power supply or malfunction

On: In operation

Flashing: In address mode: Pulses according to set address (1...16)

When starting: Reset to factory setting (Communication)

Press button: In standard mode: Triggers angle of rotation adaptation  
In address mode: Confirmation of set address (1...16)

**3 Push-button and LED display yellow**

Off: Standard mode

On: Adaptation or synchronising process active  
or actuator in address mode (LED display green flashing)

Flickering: BACnet / Modbus communication active

Press button: In operation (>3 s): Switch address mode on and off

In address mode: Address setting by pressing several times  
When starting (>5 s): Reset to factory setting (Communication)

**4 Gear disengagement button**

Press button: Gear disengages, motor stops, manual override possible

Release button: Gear engages, synchronisation starts, followed by standard mode

**5 Service plug**

For connecting parameterisation and service tools

**Check power supply connection**

**2** Off and **3** On Possible wiring error in power supply

## Service

**Quick addressing**

1. Press the "Address" button until the green "Power" LED is no longer illuminated. LED flashes in accordance with the previously set address.

2. Set the address by pressing the "Address" button the corresponding number of times (1...16).

3. The green LED flashes in accordance with the address that has been entered (...16). If the address is not correct, then this can be reset in accordance with Step 2.

4. Confirm the address setting by pressing the green "Adaption" button.

If no confirmation occurs for 60 seconds, then the address procedure is ended. Any address change that has already been started will be discarded.

The resulting BACnet MS/TP and Modbus RTU address is made up of the set basic address plus the short address (e.g. 100+7=107).

**Service Tools connection**

The actuator can be parametrised by ZTH EU via the service socket.

For an extended parametrisation the PC tool can be connected.

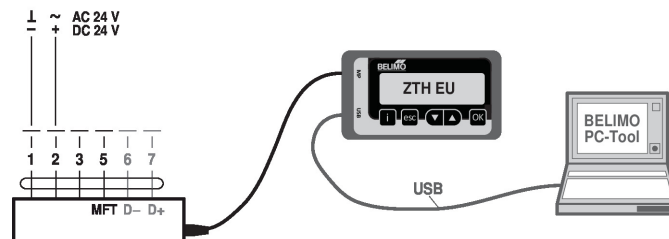



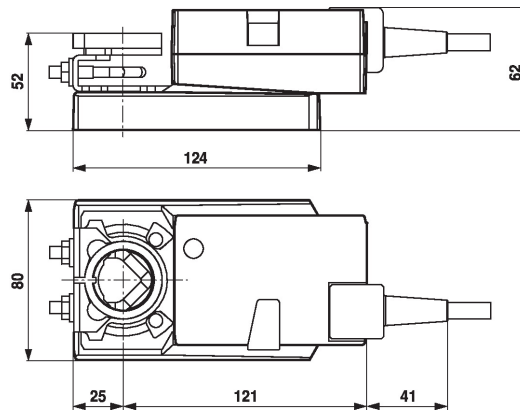

## Dimensions

## Dimensional drawings



## Clamping range

			
	8...26.7	$\geq 8$	$\leq 26.7$
	8...20	$\geq 8$	$\leq 20$

\* Option (Accessory K-NA)

\*Option: Shaft clamp mounted below (accessories K-NA needed)

## Shaft length

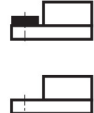
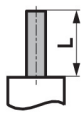

Min. 40

Min. 20

## Further documentation

- Tool connections
- Description Protocol Implementation Conformance Statement PICS
- Description Modbus register
- Overview MP Cooperation Partners
- MP Glossary
- Introduction to MP-Bus Technology

## Application notes

- For digital control of actuators in VAV applications patent EP 3163399 must be considered.