

Self-cleaning ventilation units made from galvanised steel plates, double-wood sandwich panels with acoustic non-flammable insulation (M0) in 17mm glass wool, dynamically balanced, aluminium centrifugal fan with backward-curved impellers, brushless DC motor situated outside the airflow, and a remote terminal box with built-in on/off switch.

Motors

High-performance, low-consumption, brushless DC motor.

KABB Models:

Single-phase 230V±10% 50/60Hz, IP55, Class F, with thermal protector, adjustable via potentiometer built into the remote terminal box or analogue input to control the fan with a 0-10V signal.

Models suitable for a range of working temperatures, from -20°C to 50°C+.

KABT Models:

Three-phase 400V±10% 50/60Hz, IP55, Class F, with thermal protector, adjustable via potentiometer built into the remote terminal or analogue input to control the fan with a 0-10V signal. Models suitable for a range of working temperatures, from -20°C to 40°C+.

Additional information

Working temperature from -20°C to 100°C.

Specific applications



Continuous



Industrial
kitchens



Backward blade impeller
Prevents dirt from accumulating on them. Dynamically balanced.

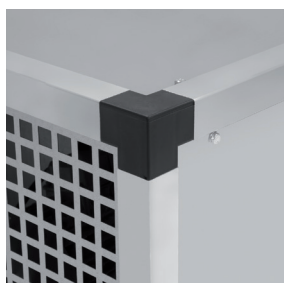

Robustness
Quality finishes, with plastic edging and aluminium profiling that provides great strength.



IP55 watertight terminal box with built-in on/off switch
Facilitates installation and maintenance.

TECHNICAL CHARACTERISTICS

It is imperative to check that the electrical characteristics (voltage, current, frequency, etc.) of the motor shown on the motor rating plate are compatible with those of the installation.

Model	Control voltage	Speed (r.p.m.)	Maximum absorbed power (W)	Maximum absorbed intensity (A)	Maximum flow rate (m³/h)	Decibel level* (dB(A)) at 1,5 m			Weight (kg)
						Outlet	Inlet	Radiated	
KABB-3000/315 ECOWATT	10	1810	512	3,1	3.180	64	65	53	35
	8	1420	252	1,6	2.480	59	60	47	
	6	1010	100	0,7	1.760	51	53	40	
	4	620	31	0,3	1.070	41	42	29	
KABB-4000/355 ECOWATT	10	1820	865	4,9	4.740	67	67	52	44
	8	1420	422	2,6	3.700	61	62	46	
	6	1030	167	1,1	2.670	54	55	39	
	4	620	47	0,4	1.600	43	44	28	
KABB-6000/450 ECOWATT	10	1510	1062	6,0	6.350	67	68	52	59
	8	1190	527	3,1	5.010	62	63	47	
	6	860	213	1,4	3.550	55	56	40	
	4	540	67	0,5	2.220	45	45	30	
KABT-9000/500 ECOWATT	10	1440	1973	3,0	8.650	69	72	58	69
	8	1280	1362	2,1	7.700	67	69	55	
	6	1060	775	1,4	6.300	63	65	51	
	4	840	391	0,9	4.950	57	60	46	
KABT-12000/560 ECOWATT	10	1450	2496	3,8	11.360	74	76	67	98
	8	1270	1692	2,6	10.080	72	73	64	
	6	1070	971	1,6	8.390	68	69	60	
	4	830	467	0,9	6.410	62	63	55	

* Average point of curve.

DIMENSIONS (mm)

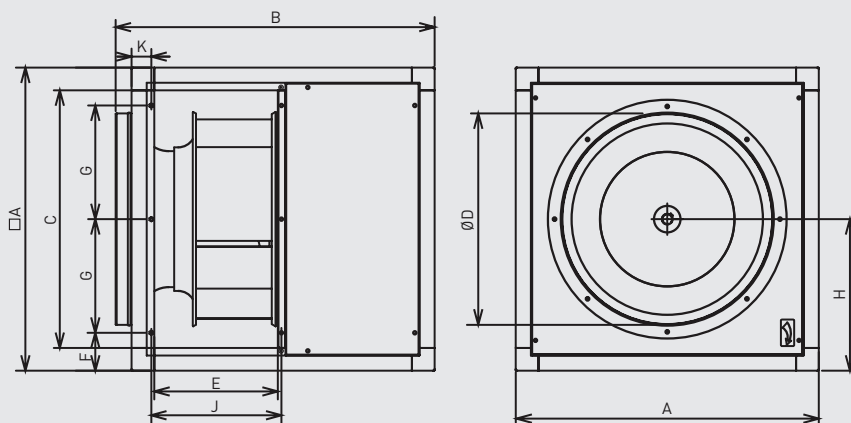

Model	A	B	C	D	E	F	G	H	J	K
KABB-3000/315	505	547	405	315	204	100	152,5	253	225,5	40
KABB-4000/355	550	592	450	355	230	100	175	275	248	40,5
KABB-6000/450	630	675	530	450	248	100	215	315	269	40
KABT-9000/500	710	753	590	500	276	100	255	355	293	51,5
KABT-12000/560	800	844	680	560	326	100	300	400	343,5	51,5

CHARACTERISTIC CURVES

- q_v = Flow rate in m^3/h and m^3/s .
- p_{sf} = Static pressure in Pa and mmcda.
- Normal dry air at 20°C and 760 mmHg.
- Tests performed according to ISO 5801 and AMCA 210-99.
- SFP: Specific fan power in $W/m^3/s$ (blue curves).

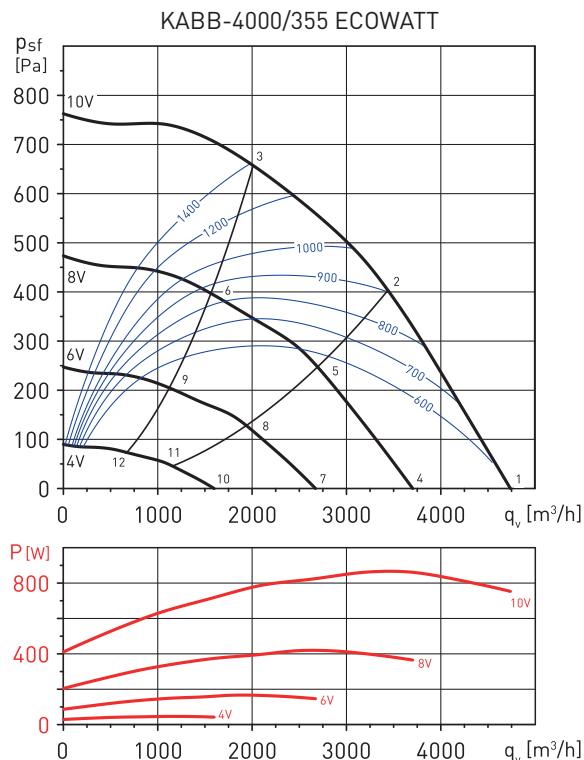
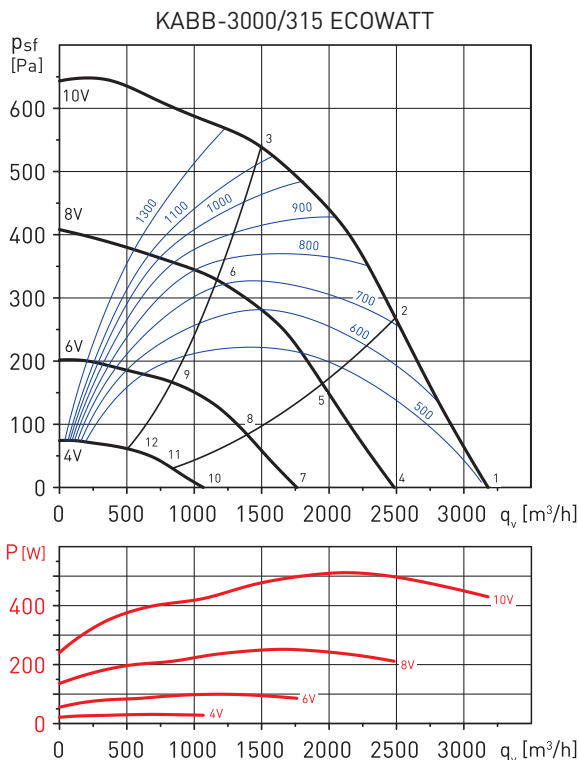

Working point		63	125	250	500	1000	2000	4000	8000	LwA
1	Inlet	50	69	77	77	74	74	71	68	82
	Outlet	47	60	70	76	77	77	73	63	82
	Radiated	40	59	68	59	53	60	47	59	70
2	Inlet	49	66	75	75	72	69	65	60	80
	Outlet	41	60	69	73	73	71	66	57	78
	Radiated	39	57	66	58	51	56	42	51	67
3	Inlet	45	65	72	74	73	71	67	61	79
	Outlet	37	58	66	71	74	73	66	58	78
	Radiated	35	55	63	56	52	58	43	52	66
4	Inlet	44	64	72	71	69	68	65	63	77
	Outlet	42	55	65	70	72	72	68	58	77
	Radiated	35	54	63	54	48	55	42	53	65
5	Inlet	43	61	69	70	67	64	60	55	74
	Outlet	35	55	64	68	68	66	60	52	73
	Radiated	33	51	60	53	46	50	36	46	62
6	Inlet	40	59	67	68	67	66	61	56	74
	Outlet	32	53	61	66	68	68	61	53	73
	Radiated	30	49	58	51	46	52	38	46	60
7	Inlet	37	56	64	64	62	61	58	55	70
	Outlet	34	47	58	63	64	64	61	51	70
	Radiated	27	47	56	47	41	48	35	46	57
8	Inlet	36	54	62	63	60	56	52	48	67
	Outlet	28	48	57	61	61	59	53	45	66
	Radiated	26	44	53	45	39	43	29	38	55
9	Inlet	33	52	59	61	60	58	54	49	66
	Outlet	24	45	53	59	61	60	54	46	66
	Radiated	23	42	51	44	39	45	31	39	53
10	Inlet	26	46	54	53	51	50	47	45	59
	Outlet	24	36	47	52	54	54	50	40	59
	Radiated	16	36	45	36	30	37	24	35	47
11	Inlet	25	43	51	52	49	46	42	37	56
	Outlet	17	37	46	50	50	48	42	34	55
	Radiated	15	33	42	35	28	32	18	27	44
12	Inlet	22	41	49	50	49	48	43	38	56
	Outlet	14	35	43	48	50	50	43	35	55
	Radiated	12	31	40	33	28	34	20	28	42

Working point		63	125	250	500	1000	2000	4000	8000	LwA
1	Inlet	52	72	81	79	77	75	75	76	86
	Outlet	51	64	74	78	80	78	76	70	85
	Radiated	43	58	66	64	56	55	52	66	71
2	Inlet	50	71	75	75	74	72	71	71	82
	Outlet	44	68	74	74	76	74	69	65	81
	Radiated	40	58	61	60	54	52	48	60	66
3	Inlet	55	69	74	75	75	72	72	70	81
	Outlet	44	61	70	72	75	73	69	64	79
	Radiated	46	56	59	60	54	52	50	59	65
4	Inlet	47	66	75	74	71	70	69	71	80
	Outlet	46	59	69	73	74	73	70	64	79
	Radiated	38	53	61	58	51	50	47	60	65
5	Inlet	44	66	70	70	69	66	65	66	76
	Outlet	39	62	69	68	70	68	64	60	76
	Radiated	35	52	55	54	48	46	43	55	61
6	Inlet	50	64	68	70	69	67	67	64	76
	Outlet	38	55	64	66	69	68	64	58	74
	Radiated	40	51	54	54	49	47	44	54	60
7	Inlet	40	59	68	67	64	63	62	64	73
	Outlet	39	52	62	66	67	66	63	57	72
	Radiated	31	46	54	51	44	43	40	53	58
8	Inlet	37	59	63	63	62	59	58	59	69
	Outlet	32	55	62	61	63	61	57	53	69
	Radiated	28	45	48	47	41	39	36	48	54
9	Inlet	43	57	61	63	62	60	60	57	69
	Outlet	31	48	57	59	62	61	57	51	67
	Radiated	33	44	47	47	42	40	37	47	53
10	Inlet	29	48	57	56	53	52	51	53	62
	Outlet	28	41	51	55	56	55	53	47	61
	Radiated	20	35	43	41	33	32	29	42	47
11	Inlet	26	48	52	52	51	49	47	48	58
	Outlet	21	45	51	51	53	51	46	42	58
	Radiated	17	34	37	36	30	28	25	37	43
12	Inlet	32	46	50	52	51	49	49	46	58
	Outlet	20	38	46	49	51	50	46	41	56
	Radiated	23	33	36	36	31	29	26	36	42

CHARACTERISTIC CURVES

- q_v = Flow rate in m^3/h and m^3/s .
- p_{sf} = Static pressure in Pa and mmca.
- Normal dry air at 20°C and 760 mmHg.
- Tests performed according to ISO 5801 and AMCA 210-99.
- SFP: Specific fan power in $W/m^3/s$ (blue curves).

KABB-6000/450 ECOWATT

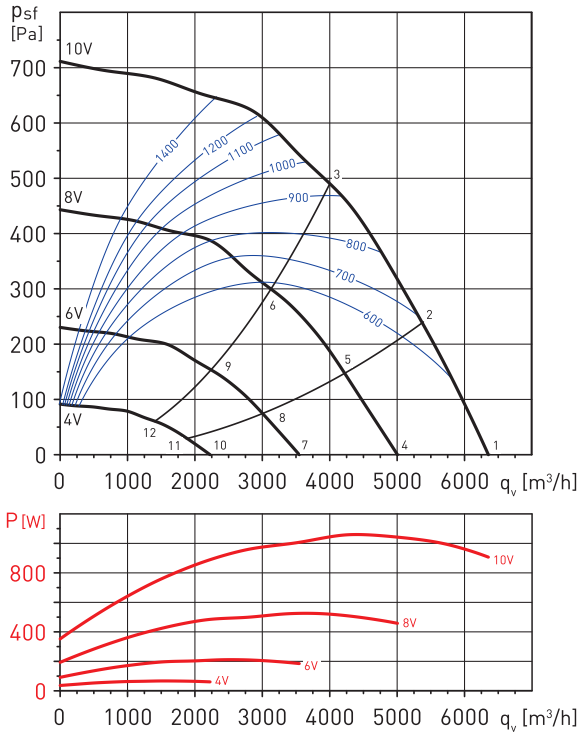

KABT-9000/500 ECOWATT

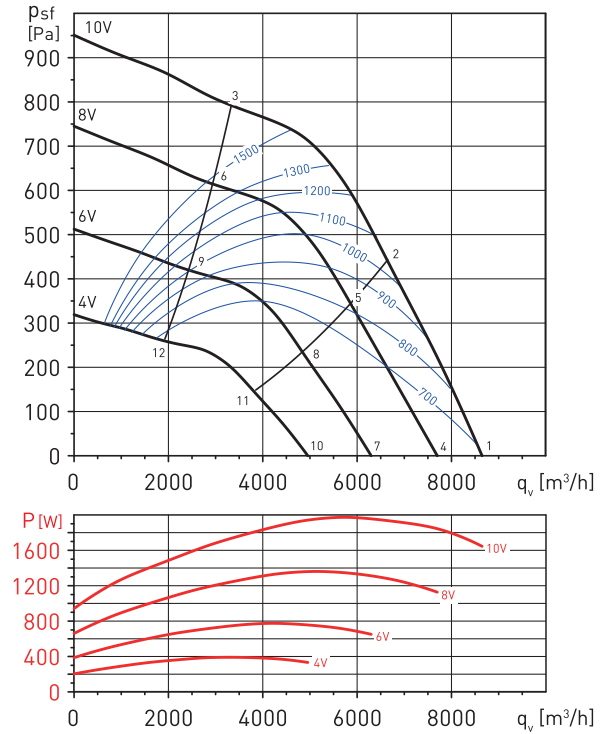

Working point		63	125	250	500	1000	2000	4000	8000	LwA
1	Inlet	49	78	79	77	74	75	74	67	84
	Outlet	54	66	71	76	78	77	76	67	83
	Radiated	44	62	66	60	55	54	52	59	69
2	Inlet	52	74	76	76	73	74	71	64	82
	Outlet	48	65	70	75	76	76	73	66	82
	Radiated	47	58	64	59	54	53	49	55	67
3	Inlet	50	73	76	75	71	72	68	63	81
	Outlet	51	66	71	75	77	76	72	65	82
	Radiated	45	58	64	57	53	50	46	55	66
4	Inlet	44	72	74	72	68	70	69	62	79
	Outlet	49	61	66	71	73	72	71	62	78
	Radiated	39	57	61	54	50	49	46	53	64
5	Inlet	47	68	71	71	68	69	66	59	77
	Outlet	43	60	65	70	71	70	68	61	77
	Radiated	42	52	58	53	49	48	44	50	61
6	Inlet	45	68	71	70	66	67	63	58	76
	Outlet	46	61	65	70	72	71	67	60	77
	Radiated	40	52	59	52	48	45	41	49	61
7	Inlet	36	65	67	65	61	63	62	55	72
	Outlet	42	54	59	64	66	64	64	54	71
	Radiated	32	49	54	47	43	42	39	46	57
8	Inlet	40	61	64	64	61	62	59	52	70
	Outlet	35	53	58	63	64	63	61	54	70
	Radiated	35	45	51	46	42	41	37	43	54
9	Inlet	38	61	64	63	59	59	56	51	69
	Outlet	39	54	58	63	64	63	60	52	70
	Radiated	33	45	51	45	41	38	34	42	54
10	Inlet	26	55	57	55	51	53	52	45	62
	Outlet	32	44	49	54	56	54	54	44	61
	Radiated	22	39	44	37	33	32	29	36	47
11	Inlet	30	51	54	54	51	52	49	42	60
	Outlet	25	43	48	53	54	53	51	44	59
	Radiated	25	35	41	36	32	31	27	33	44
12	Inlet	28	51	54	53	49	49	46	41	59
	Outlet	29	44	48	53	54	53	50	42	60
	Radiated	23	35	41	35	31	28	24	32	44

Working point		63	125	250	500	1000	2000	4000	8000	LwA
1	Inlet	61	84	80	81	83	84	78	78	90
	Outlet	56	68	75	80	86	88	77	71	91
	Radiated	50	71	71	62	66	63	57	60	75
2	Inlet	62	77	80	80	78	77	76	75	86
	Outlet	51	68	74	77	79	77	73	69	84
	Radiated	50	64	70	61	61	56	56	57	72
3	Inlet	70	85	81	80	79	77	77	74	89
	Outlet	58	71	74	78	79	77	73	67	84
	Radiated	58	72	71	62	61	56	56	56	75
4	Inlet	58	81	77	78	80	81	75	75	87
	Outlet	53	65	72	78	83	85	74	68	88
	Radiated	47	68	68	60	63	60	54	57	72
5	Inlet	59	74	77	77	76	74	73	72	84
	Outlet	48	65	71	75	77	74	70	66	81
	Radiated	48	61	67	58	58	53	53	54	69
6	Inlet	67	83	78	78	76	75	74	71	86
	Outlet	55	69	71	75	76	74	70	64	81
	Radiated	56	69	69	59	58	54	54	53	73
7	Inlet	54	77	73	74	76	77	71	71	83
	Outlet	49	61	68	74	79	81	70	64	84
	Radiated	43	64	64	56	59	56	50	53	68
8	Inlet	55	70	73	73	71	70	69	68	79
	Outlet	44	61	67	70	72	70	66	62	77
	Radiated	44	57	63	54	54	49	49	50	65
9	Inlet	63	78	74	74	72	70	70	67	82
	Outlet	51	65	67	71	72	70	66	60	77
	Radiated	52	65	65	55	54	50	49	49	69
10	Inlet	49	72	68	69	71	72	66	66	78
	Outlet	44	56	63	68	74	76	65	59	79
	Radiated	38	59	59	50	54	51	45	48	63
11	Inlet	50	65	68	68	66	65	64	63	74
	Outlet	39	56	62	65	67	65	61	57	72
	Radiated	38	52	58	49	49	44	44	45	60
12	Inlet	58	73	69	68	67	65	65	62	77
	Outlet	46	59	62	66	67	65	61	55	72
	Radiated	46	60	59	50	49	44	44	44	63

CHARACTERISTIC CURVES

- q_v = Flow rate in m^3/h and m^3/s .
- p_{sf} = Static pressure in Pa and mmcda.
- Normal dry air at 20°C and 760 mmHg.
- Tests performed according to ISO 5801 and AMCA 210-99.
- SFP: Specific fan power in $W/m^3/s$ (blue curves).

KABT-12000/560 ECOWATT

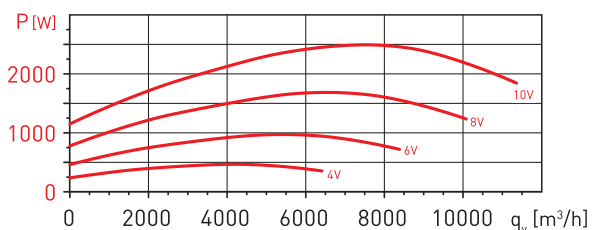
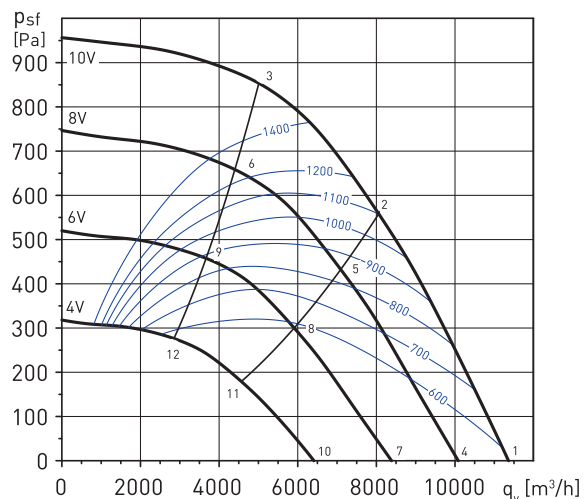

Working point		63	125	250	500	1000	2000	4000	8000	LwA
1	Inlet	61	84	84	80	85	85	78	81	91
	Outlet	59	87	81	84	90	92	80	78	95
	Radiated	53	75	80	65	70	67	60	65	82
2	Inlet	56	81	85	76	78	81	76	75	89
	Outlet	55	87	77	80	83	81	77	73	90
	Radiated	48	72	81	62	64	62	57	59	81
3	Inlet	62	80	87	77	77	79	75	71	89
	Outlet	62	80	78	79	80	78	75	71	87
	Radiated	55	71	83	63	62	61	57	56	83
4	Inlet	58	81	81	77	82	82	75	78	89
	Outlet	56	84	78	81	87	89	77	75	93
	Radiated	50	72	77	63	67	64	57	63	79
5	Inlet	53	78	83	73	76	78	73	72	86
	Outlet	52	84	74	77	80	78	74	71	87
	Radiated	45	69	78	59	61	60	54	56	79
6	Inlet	60	77	85	74	74	77	72	69	87
	Outlet	59	78	76	76	77	75	72	68	84
	Radiated	52	68	80	60	60	58	54	53	80
7	Inlet	54	77	78	73	78	78	72	75	85
	Outlet	52	81	74	77	83	85	73	71	89
	Radiated	46	68	73	59	64	60	53	59	75
8	Inlet	49	74	79	69	72	74	69	68	82
	Outlet	48	80	70	73	76	74	70	67	83
	Radiated	41	65	74	55	57	56	51	52	75
9	Inlet	56	73	81	70	70	73	68	65	83
	Outlet	55	74	72	72	73	71	68	64	80
	Radiated	48	64	76	56	56	55	50	49	76
10	Inlet	49	72	72	68	72	73	66	69	79
	Outlet	47	75	69	72	78	80	68	66	83
	Radiated	41	63	67	53	58	54	48	53	69
11	Inlet	44	69	73	64	66	68	64	63	77
	Outlet	42	75	65	68	71	69	65	61	78
	Radiated	36	60	69	50	52	50	45	47	69
12	Inlet	50	68	75	65	65	67	63	59	77
	Outlet	50	68	66	66	68	66	63	59	74
	Radiated	43	59	71	51	50	49	45	43	71

MOUNTING ACCESSORIES



USD-N
Circular coupling flange
To fit to the outlet.

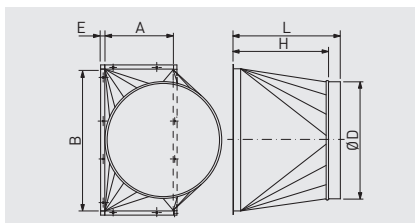

Model	A	B	D	E	L	H
USD-3000 NV	204	405	315	20	450	400
USD-4000 NV	230	450	355	20	450	400
USD-6000 NV	248	530	450	20	450	400
USD-9000 NV	276	590	500	20	450	400
USD-12000 NV	326	680	560	20	450	400

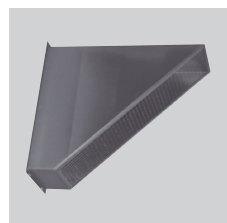

ASV KABT
Protection guards
Wire protection guards for mounting on the cabinet fan discharge.

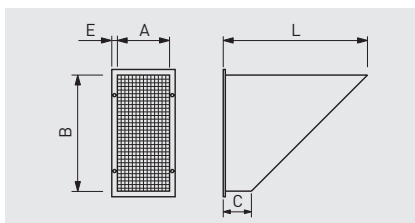

Model	A	B	C	E	L
ASV-3000 NV	204	405	100	20	500
ASV-4000 NV	230	450	100	20	545
ASV-6000 NV	248	530	100	20	625
ASV-9000 NV	276	590	100	20	685
ASV-12000 NV	326	680	100	20	775



CTI KABT
Outdoor cover
For outdoor installations.

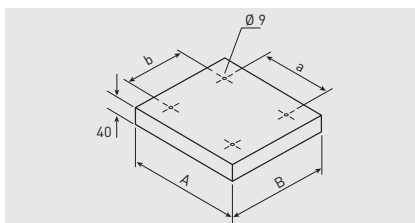

Model	A	B	a	b
CTI KABT-3000 N	535	535	305	420,7
CTI KABT-4000 N	580	580	350	465,5
CTI KABT-6000 N	660	660	430	545,5
CTI KABT-9000 N	740	740	510	605,5
CTI KABT-12000 N	830	830	600	695,5

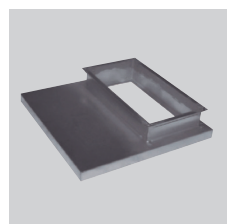

WDS KABT
Outdoor cover with rectangular coupling flange
For vertical discharge in outdoor installations.

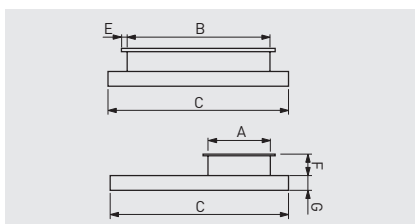

Model	A	B	C	E	F	G
WDS-3000 NV	204	405	535	20	80	40
WDS-4000 NV	230	450	580	20	80	40
WDS-6000 NV	248	530	660	20	80	40
WDS-9000 NV	276	590	740	20	80	40
WDS-12000 NV	326	680	830	20	80	40



ACOP RECT KABT
Rectangular elastic coupling
To fit to the outlet. Avoids transmission of vibrations.

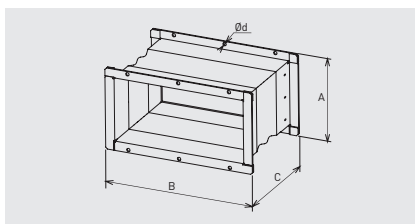

Model	A	B	C	d
ACOP RECT KABT-3000 N	242	441	143	9
ACOP RECT KABT-4000 N	265	486	143	9
ACOP RECT KABT-6000 N	285	566	143	9
ACOP RECT KABT-9000 N	312	626	143	9
ACOP RECT KABT-12000 N	362	716	143	9



KSE
Vibration damping supports
Rubber vibration damping supports that reduce vibrations and attenuate the noise of the installation. (1 KSE = 4 supports in a bag).



ACOPEL F400 N
Circular flexible connector. Certified F400-120.

Model	Flexible connector
KABB-KABT/4-3000/315	ACOPEL F400-315/160N
KABB-KABT/4-4000/355	ACOPEL F400-355/160N
KABB-KABT/4-6000/450	ACOPEL F400-450/160N
KABB-KABT/4-9000/500	ACOPEL F400-500/160N
KABB-KABT/4-12000/560	ACOPEL F400-560/160N

ELECTRICAL ACCESSORIES



REB-ECOWATT
Speed controller.



ECOWATT BASIC CONTROL
Speed control and on/off switch.



CPTA-S/CPTA-E
Presence detector.



TDP-S/TDP-D/TDP-PI
Pressure transmitters.