

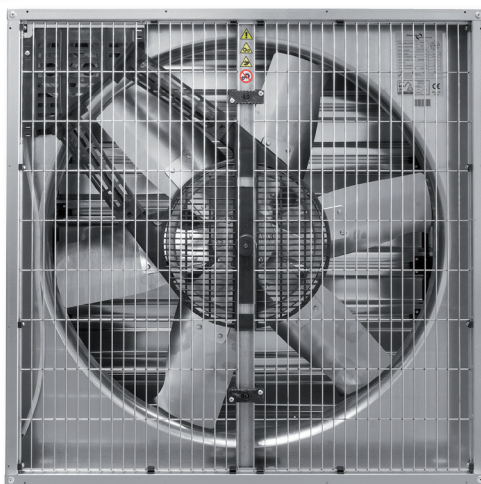

Outlet louvre shutter side



Inlet guard side

Wall mounted axial flow fans with galvanised steel sheet structure, outlet louvre shutter with mechanical opening, inlet guard from galvanised steel and belt driven impeller from aluminium sheet (except Ø 800 direct driven models), powered by single phase (HIB) or three phase (HIT) motor. IP55, Class F.

Motors

Electrical supplies:

Single phase 230V-50Hz.

Three phase 230/400V-50Hz.

High-efficiency, IE3: three-phase models from 0,75 to 1,5kW.

On request

60 Hz models and models without shade, with defense on the discharge side can be supplied.



Specific applications



Agricultural extract or supply applications



Compact design

Robust casings manufactured from galvanised steel sheet.



Outlet louvre shutter with automatic opening

when switching on the fan, to avoid its opening when it is not working.



Metallic protection guard on the inlet side, made from galvanised steel.

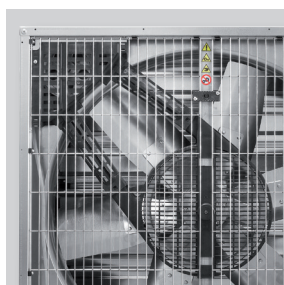

Protected belt-driven assembly

Trapezoidal belt drive protected by a belt guard from PVC.

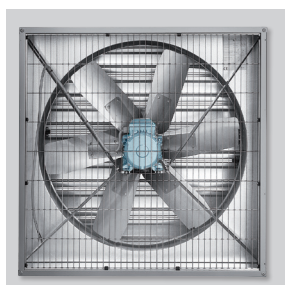

Ø 800 direct driven models.

TECHNICAL CHARACTERISTICS

Before making any electrical connection ensure that the voltage and frequency of the mains electrical supply matches that of the fan data plate label.

Model	Motor Power (kW)	Maximum absorbed current* (A)	Diameter (mm)	Maximum air volume (m ³ /h)	Motor speed* (r.p.m.)	Impeller speed* (r.p.m.)	Sound pressure level (dB(A))**	Weight (kg)
SINGLE PHASE								
HIB-800-P-0,55	0,55	3,2	800	15.450	910	935	71	48
HIB-1000-P-0,37	0,37	3	1000	20.700	1400	481	66	50
HIB-1000-P-0,55	0,55	4,4	1000	22.600	1400	525	67	52
HIB-1000-P-0,75	0,75	5,5	1000	24.900	1400	579	70	54
HIB-1250-P-0,75	0,75	5,5	1250	34.300	1400	393	67	69
HIB-1250-P-1,1	1,1	7,6	1250	40.900	1400	473	69	74

*230V 50Hz values.

THREE PHASE								
Model	Motor Power (kW)	Maximum absorbed current* (A)	Diameter (mm)	Maximum air volume (m ³ /h)	Motor speed* (r.p.m.)	Impeller speed* (r.p.m.)	Sound pressure level (dB(A))**	Weight (kg)
HIT-800-P-0,55	0,55	3,2 / 1,6	800	15.450	910	935	71	48
HIT-1000-P-0,37	0,37	1,6 / 0,9	1000	20.700	1400	481	66	50
HIT-1000-P-0,55	0,55	2,4 / 1,4	1000	22.600	1400	525	67	52
HIT-1000-P-0,75	0,75	3,4 / 2,0	1000	24.900	1400	579	70	54
HIT-1250-P-0,75	0,75	3,4 / 2,0	1250	34.300	1400	393	67	69
HIT-1250-P-1,1	1,1	4,5 / 2,6	1250	40.900	1400	473	69	74
HIT-1250-P-1,5	1,5	6,3 / 3,6	1250	44.500	1400	516	75	80

* 230/400V 50Hz values.

** Sound pressure measured at a distance equivalent to 3 times the diameter, in free field.

ACOUSTIC CHARACTERISTICS

Model	63	125	250	500	1000	2000	4000	8000	LwA
800	54	71	82	85	84	80	74	64	89
1000 - 0,37	62	72	79	83	80	75	68	58	86
1000 - 0,55	64	73	81	84	82	77	69	59	88
1000 - 0,75	66	76	83	87	84	79	72	62	90
1250 - 0,75	69	73	80	87	82	77	69	59	89
1250 - 1,1	67	77	85	87	85	80	73	63	91
1250 - 1,5	66	81	88	90	89	84	77	67	95

DIMENSIONS (mm)

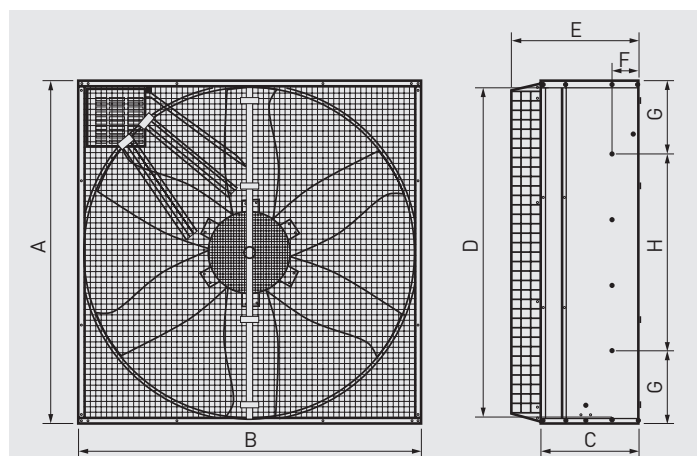

Model	A	B	C	D	E	F	G	H
HIT / HIT 800 P	905	907	530	645	780	252,5	225	455
HIT / HIT 1000 P	1145	1145	400	1060	515	109	225	692
HIT / HIT 1200 P	1380	1380	400	1340	515	114	292	795

PERFORMANCE CURVES

- q_v : Air volume in m^3/h and m^3/s .
- p_{sf} : Static pressure in Pa.
- Dry air at 20°C and 760 mmHg.
- Performance data in accordance with ISO 5801 and AMCA 210-99 Standards.

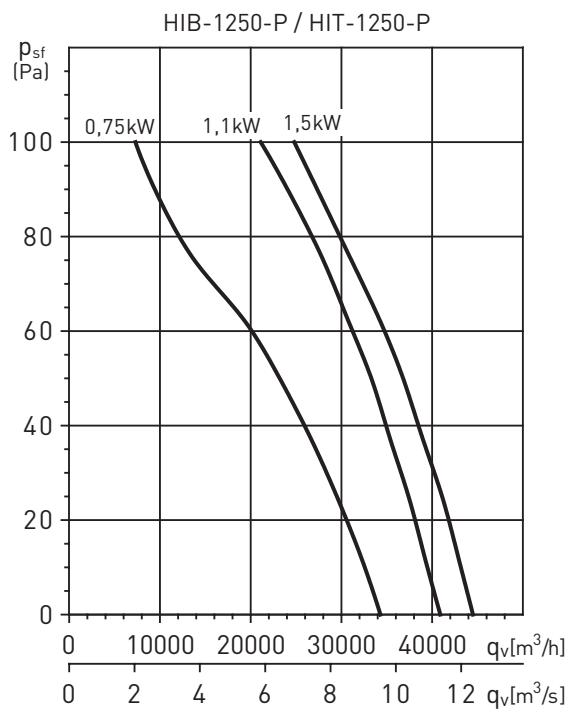
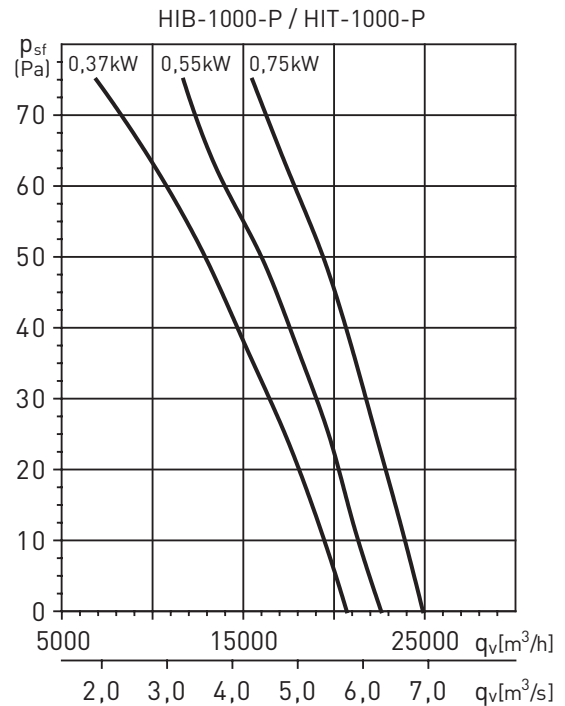
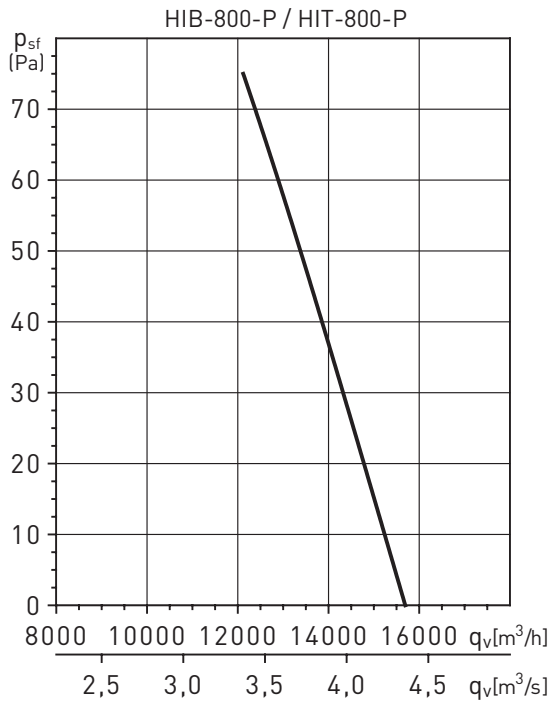

MOUNTING ACCESSORIES

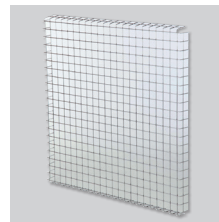

Safety guard kit

Electro-welded steel mesh protection guard with frame to fit at fan discharge to prevent access to the moving parts. The installations must include this accessory to comply with the European Machinery Directive if the lowest point of the fan is mounted at less than 2,5 m from the floor level.



Black-Out Kit

Metallic protection Panel which avoids the entry of natural light. Specially recommended for poultry ventilation applications.

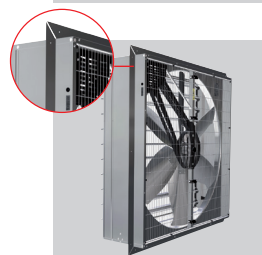

KIT FOR FIXING THE HIT/HIB WALL

Fixing profiles for correct installation of the fans to the wall.