

ENR 20



Short description

Axial wall-mounted fan for ventilation and air extraction, DN 200

Application examples

Office, Office, Commercial premises, Restaurant, Production facility

Article number 0081.0316

Technical data

Air flow volume	460 m ³ /h
Rotating speed	1.380 1/min
Impeller type	axial
Air direction	Ventilation or air extraction
Speed controllable	✓
Reversing capacity	✓
Type of voltage	Alternating current
Rated voltage	230 V
Frequency	50 Hz
Nominal output	42 W
I _{nom}	0,15 A
I _{max}	0,21 A
Degree of protection	IP 44
Mains cable	5 x 1,5 mm ²
Installation site	Wall / Ceiling
Type of installation	Surface-mounted
Installation position	any
Material	Synthetic material
Colour	Traffic white, similar to RAL 9016
Weight	2,7 kg
Weight including packaging	3,26 kg
Nominal size	200 mm
Width	320 mm
Height	320 mm
Depth	158 mm
Width with packaging	355 mm
Height with packaging	355 mm
Depth with packaging	185 mm
Airstream temperature at I _{Max}	40 °C

ENR 20

Sound pressure level	48 dB(A)
Packing unit	1 piece
Range	C
GTIN (EAN)	4012799813163

Sound power level in octave range

	63 Hz	125 Hz	250 Hz	500 Hz	1 kHz	2 kHz	4 kHz	8 kHz	Total
L_{WA7, high} (dB(A))	-	-	-	-	-	-	-	-	57

L_{WA7}= housing and free inlet sound power level in dB.

Characteristic curve

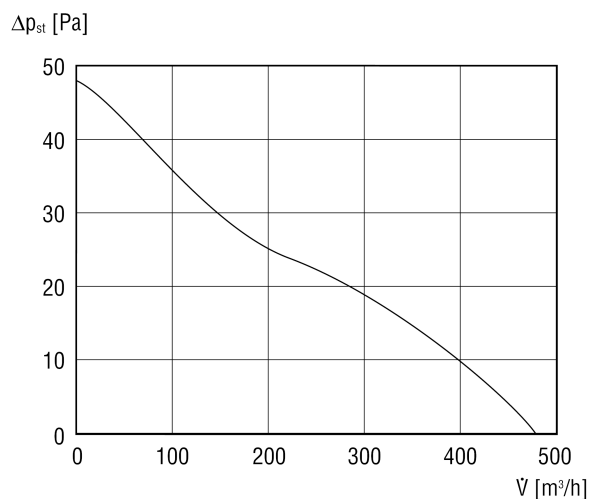

ENR 20

Dimensioned drawing [mm]

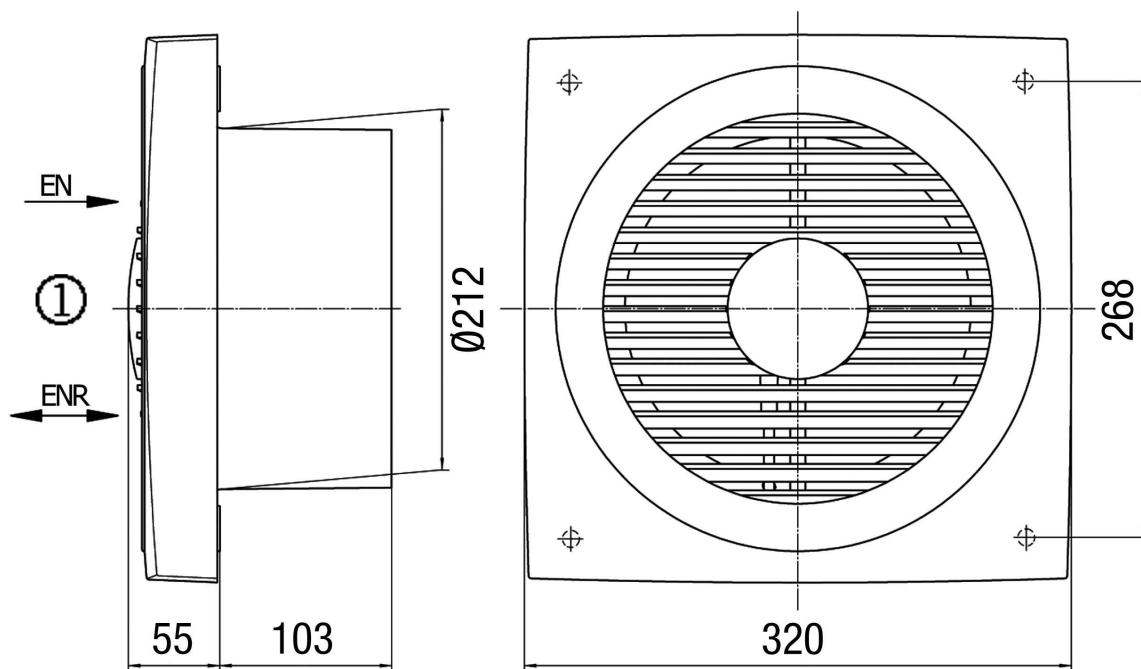

① Inside