

DZR 50/6 B Ex t



Short description

Axial duct fan, DN500, three-phase AC, explosion-proof, medium: dust

Article number 0086.0733

Technical data

Air flow volume	5.520 m ³ /h
Speed controllable	✓
Reversing capacity	✓
Type of voltage	Three-phase AC
Rated voltage	400 V
Frequency	50 Hz
Nominal output	175 W
cosφ	0,44
I _{nom}	0,57 A
I _{max} at U _{Nominal}	0,74 A
Degree of protection	IP 64
Insulation class	F
Material	Sheet steel, galvanised
Colour	galvanised
Weight	16,7 kg
Weight including packaging	20,41 kg
Nominal size	500 mm
Width	624 mm
Height	624 mm
Depth	370 mm
Width with packaging	635 mm
Height with packaging	640 mm
Depth with packaging	410 mm
EX designation in accordance with the ATEX Directive	Ex II 2 D
EX designation in accordance with standard	Ex tb IIIB T135°C Db IP64 X / Ex h IIIB T135°C Db X
Ta ambient temperature	-20 °C ≤ Ta ≤ +40 °C
Time t _A	240 sek
Operating mode	S1
PTC DIN 44082	M 100

DZR 50/6 B Ex t

EC type examination certificate	TÜV-A 19 ATEX0103 X, IECEx EPS 19.0019X
Temperature class	T135°C
Temperature class of insulating materials Th. Cl.	155 (F)
Packing unit	1 piece
Range	C
GTIN (EAN)	4012799867333

Characteristic curve

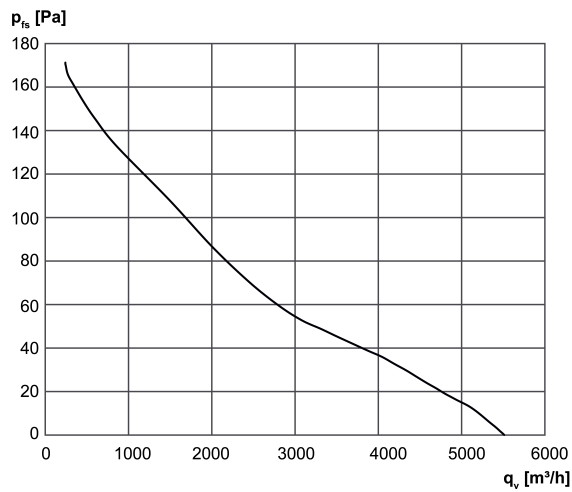

DZR 50/6 B Ex t

Dimensioned drawing [mm]

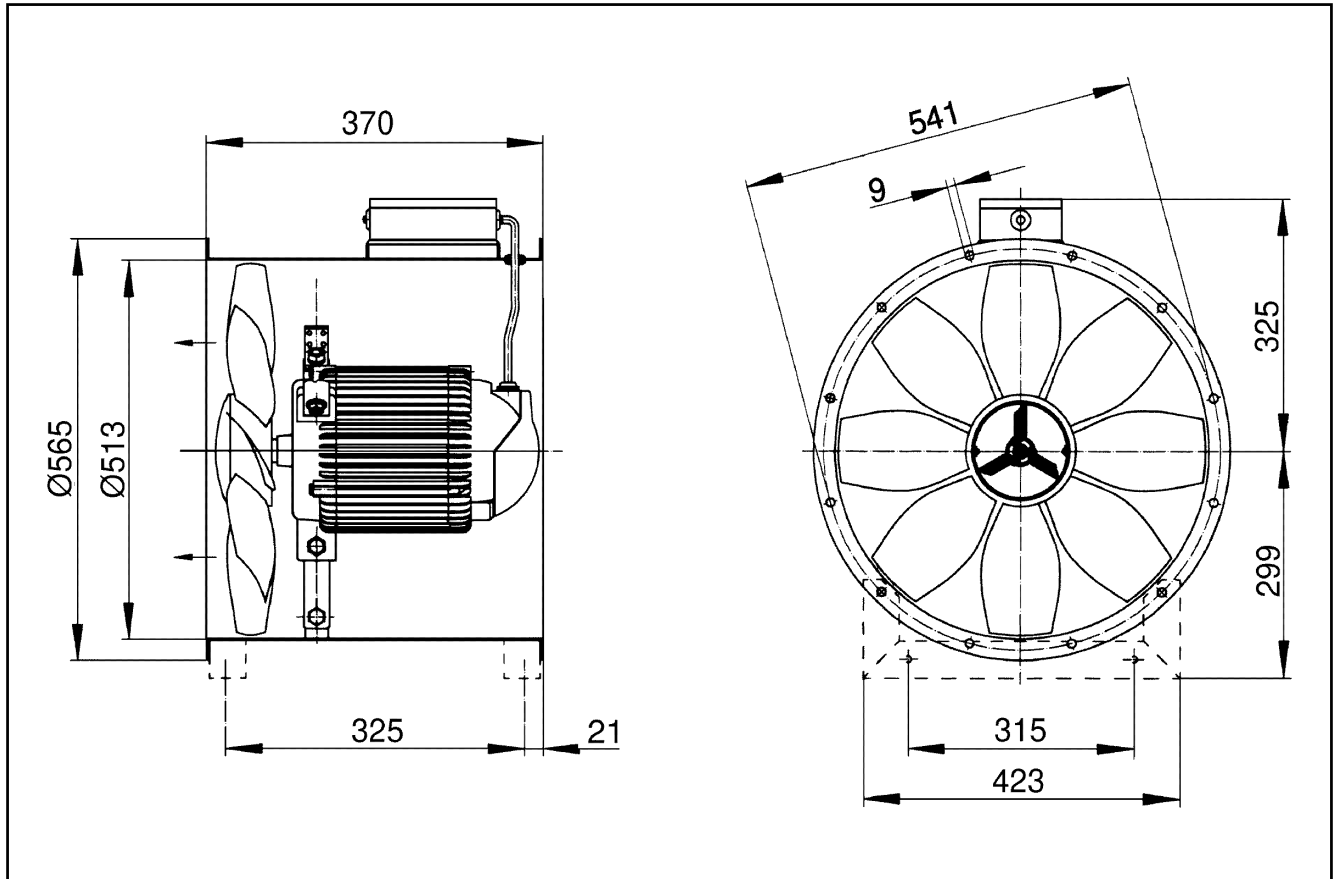

Number of flange holes: 12