

DZR 50/4 B Ex t



Short description

Axial duct fan, DN500, three-phase AC, explosion-proof, medium: dust

Article number 0086.0734

Technical data

Air flow volume	8.190 m ³ /h
Speed controllable	✓
Reversing capacity	✓
Type of voltage	Three-phase AC
Rated voltage	400 V
Frequency	50 Hz
Nominal output	445 W
cosφ	0,75
I _{nom}	0,86 A
I _{max} at U _{Nominal}	1,71 A
Degree of protection	IP 64
Insulation class	F
Material	Sheet steel, galvanised
Colour	galvanised
Weight	22,7 kg
Weight including packaging	26,35 kg
Nominal size	500 mm
Width	624 mm
Height	624 mm
Depth	370 mm
Width with packaging	635 mm
Height with packaging	640 mm
Depth with packaging	410 mm
EX designation in accordance with the ATEX Directive	Ex II 2 D
EX designation in accordance with standard	Ex tb IIIB T200°C Db IP64 X / Ex h IIIB T200°C Db X
Ta ambient temperature	-20 °C ≤ Ta ≤ +60 °C
Time t _A	240 sek
Operating mode	S1
PTC DIN 44082	M 130

DZR 50/4 B Ex t

EC type examination certificate	TÜV-A 19 ATEX0103 X, IECEx EPS 19.0019X
Temperature class	T200°C
Temperature class of insulating materials Th. Cl.	155 (F)
Packing unit	1 piece
Range	C
GTIN (EAN)	4012799867340

Characteristic curve

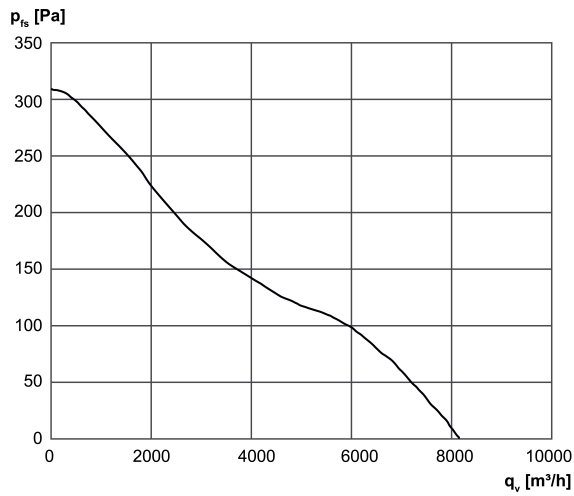

DZR 50/4 B Ex t

Dimensioned drawing [mm]

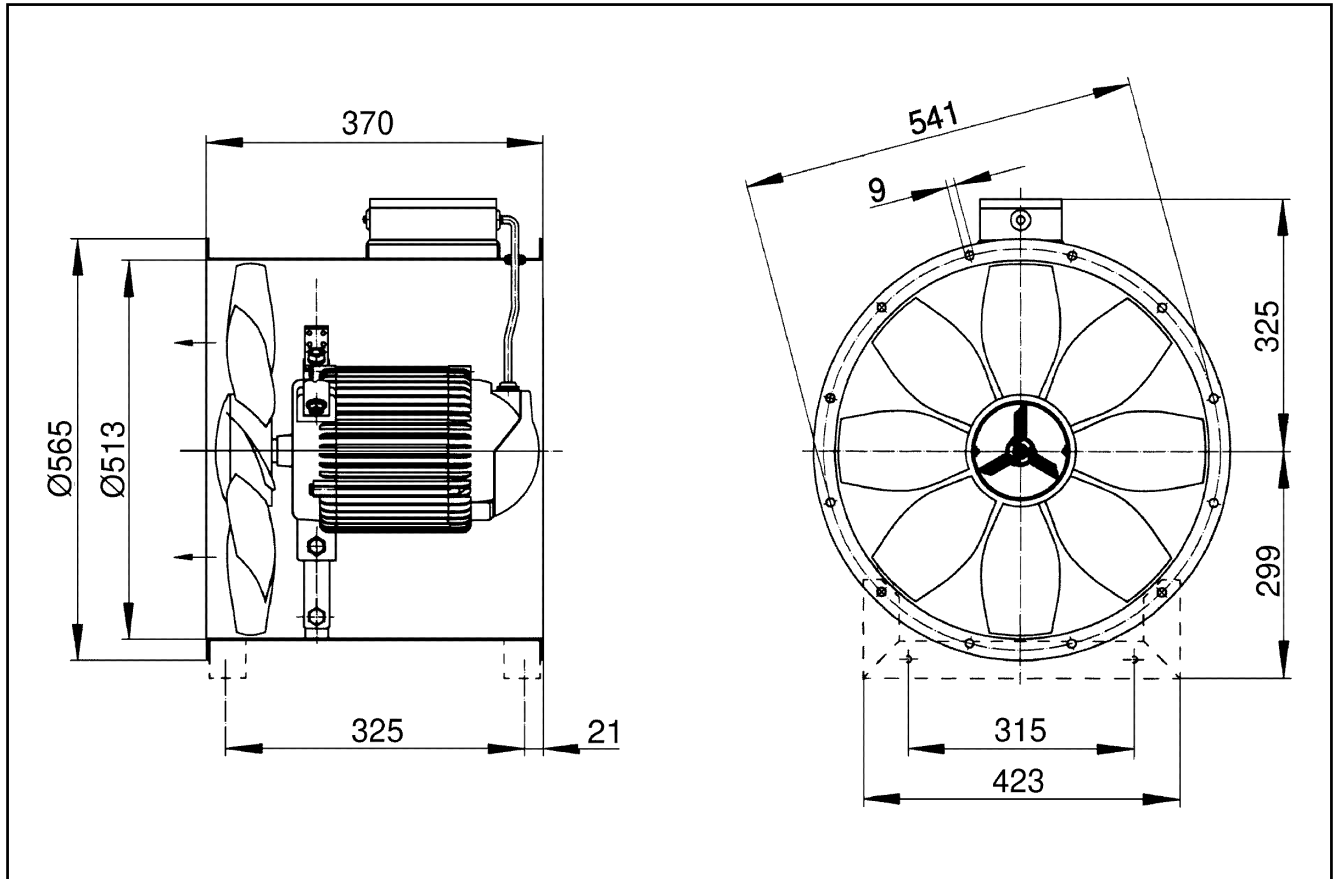

Number of flange holes: 12