

DZR 45/6 B Ex t



Short description

Axial duct fan, DN450, three-phase AC, explosion-proof, medium: dust

Article number 0086.0731

Technical data

Air flow volume	4.160 m ³ /h
Speed controllable	✓
Reversing capacity	✓
Type of voltage	Three-phase AC
Rated voltage	400 V
Frequency	50 Hz
Nominal output	150 W
cosφ	0,38
I _{nom}	0,56 A
I _{max} at U _{Nominal}	0,61 A
Degree of protection	IP 64
Insulation class	F
Material	Sheet steel, galvanised
Colour	galvanised
Weight	15 kg
Weight including packaging	17,25 kg
Nominal size	450 mm
Width	571 mm
Height	571 mm
Depth	310 mm
Width with packaging	571 mm
Height with packaging	580 mm
Depth with packaging	340 mm
EX designation in accordance with the ATEX Directive	Ex II 2 D
EX designation in accordance with standard	Ex tb IIIB T135°C Db IP64 X / Ex h IIIB T135°C Db X
Ta ambient temperature	-20 °C ≤ Ta ≤ +40 °C
Time t _A	240 sek
Operating mode	S1
PTC DIN 44082	M 100

DZR 45/6 B Ex t

EC type examination certificate	TÜV-A 19 ATEX0103 X, IECEx EPS 19.0019X
Temperature class	T135°C
Temperature class of insulating materials Th. Cl.	155 (F)
Packing unit	1 piece
Range	C
GTIN (EAN)	4012799867319

Characteristic curve

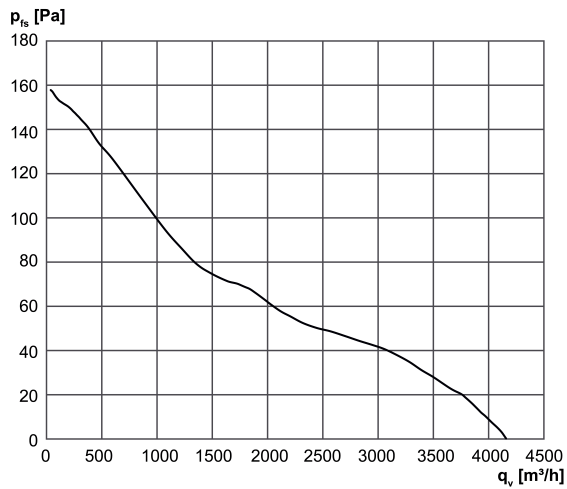

DZR 45/6 B Ex t

Dimensioned drawing [mm]

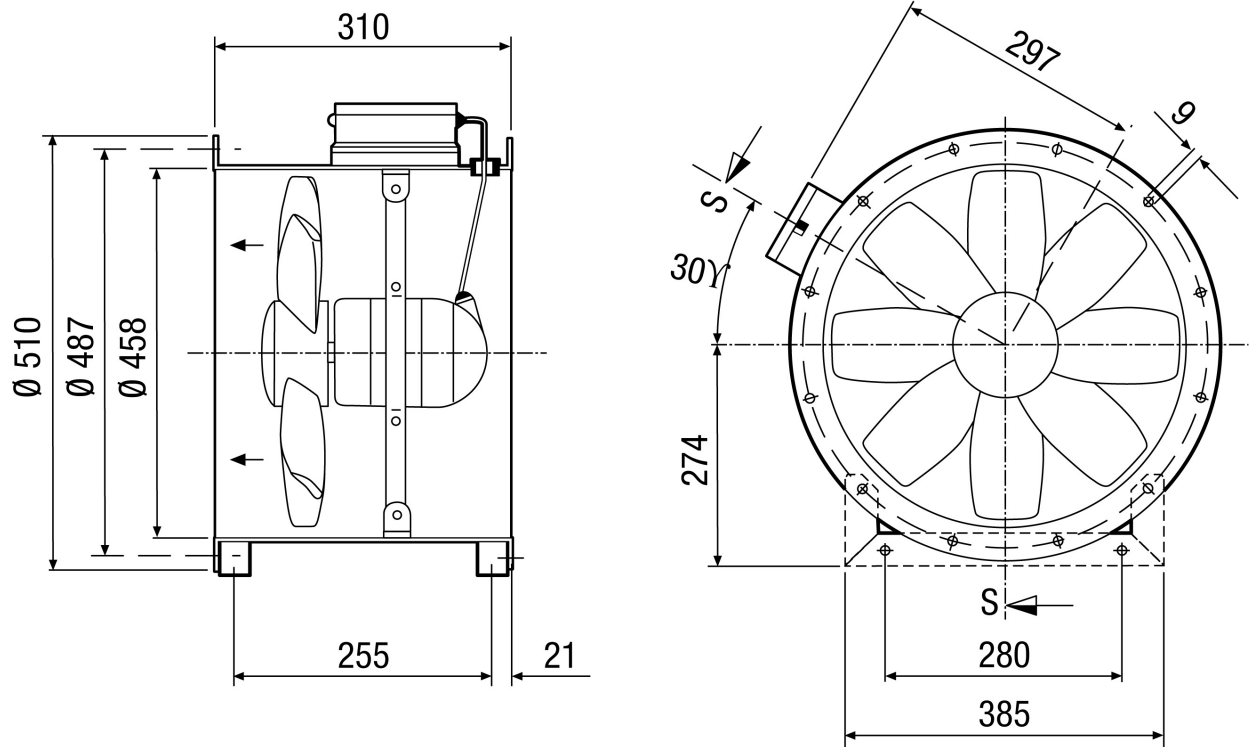

Number of flange holes: 12