

DZR 45/4 B Ex e



Short description

Axial duct fan, DN450, three-phase AC, explosion-proof, medium: gas

Application examples

Environment with explosion hazard (zone 1 and 2), Workshop, Storage facility, Laboratory, Workplace air extraction system

Article number 0086.0712

Technical data

Air flow volume	6.200 m ³ /h
Rotating speed	1.420 1/min
Impeller type	axial
Speed controllable	✓
Reversing capacity	✓
Type of voltage	Three-phase AC
Rated voltage	400 V
Frequency	50 Hz
Nominal output	350 W
cosφ	0,68
I _{nom}	0,72 A
I _{max} at U _{Nominal}	1,02 A
Degree of protection	IP 64
Insulation class	F
Installation position	vertical / horizontal
Material	Sheet steel, galvanised
Housing material	Sheet steel, galvanised
Colour	galvanised
Weight	15,03 kg
Weight including packaging	17,25 kg
Nominal size	450 mm
Width	571 mm
Height	571 mm
Depth	310 mm
Width with packaging	572 mm
Height with packaging	580 mm
Depth with packaging	340 mm
EX designation in accordance with the ATEX Directive	Ex II 2 G
EX designation in accordance with standard	Ex eb IIB + H ₂ T4 Gb / Ex h IIB + H ₂ T4 Gb

DZR 45/4 B Ex e

Ta ambient temperature	-20 °C ≤ Ta ≤ +40 °C
I _A /I _N	4,3
Time t _A	110 sek
Operating mode	S1
PTC DIN 44082	M 100
EC type examination certificate	TÜV-A 19 ATEX0103 X, IECEx EPS 19.0019X
Temperature class	T4
Temperature class of insulating materials Th. Cl.	155 (F)
Packing unit	1 piece
Range	C
GTIN (EAN)	4012799867128

Sound power level in octave range

	63 Hz	125 Hz	250 Hz	500 Hz	1 kHz	2 kHz	4 kHz	8 kHz	Total
L _{WA5, high} (dB(A))	-	-	-	-	-	-	-	-	78

L_{WA5}= free inlet sound power level in dB.

Characteristic curve

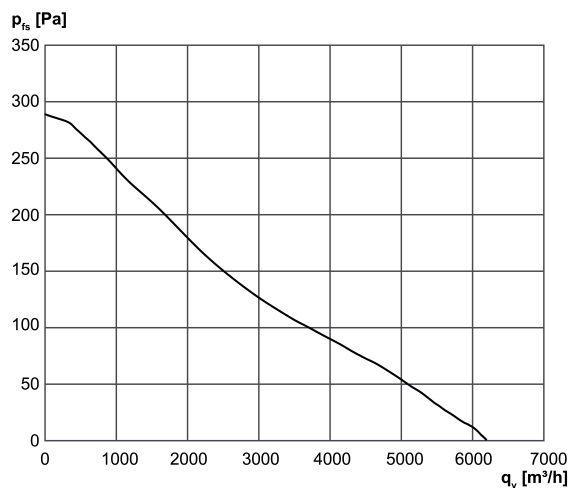

DZR 45/4 B Ex e

Dimensioned drawing [mm]

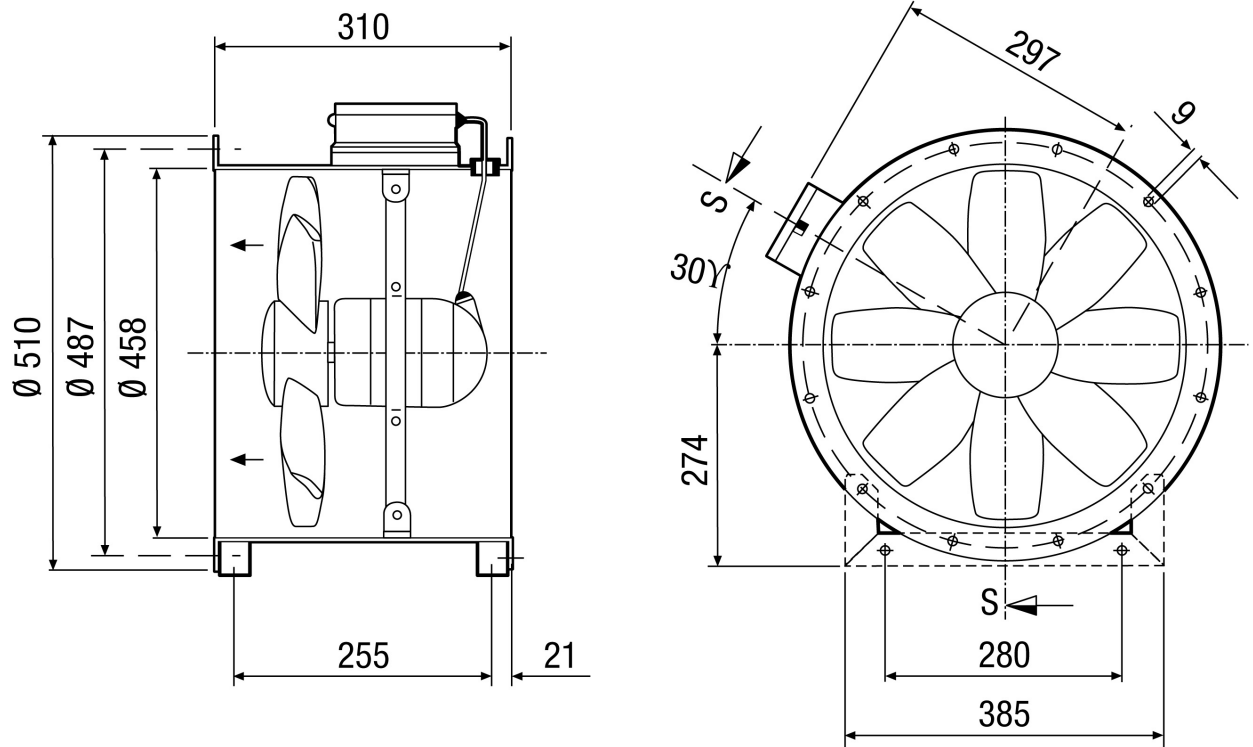

Number of flange holes: 12