

DZR 30/4 B Ex t



Short description

Axial duct fan, DN300, three-phase AC, explosion-proof, medium: dust

Article number 0086.0724

Technical data

Air flow volume	1.760 m ³ /h
Speed controllable	✓
Reversing capacity	✓
Type of voltage	Three-phase AC
Rated voltage	400 V
Frequency	50 Hz
Nominal output	95 W
cosφ	0,28
I _{nom}	0,48 A
I _{max} at U _{Nominal}	0,49 A
Degree of protection	IP 64
Insulation class	F
Material	Sheet steel, galvanised
Colour	galvanised
Weight	9,5 kg
Weight including packaging	10,39 kg
Nominal size	300 mm
Width	424 mm
Height	424 mm
Depth	300 mm
Width with packaging	420 mm
Height with packaging	430 mm
Depth with packaging	330 mm
EX designation in accordance with the ATEX Directive	Ex II 2 D
EX designation in accordance with standard	Ex tb IIIB T200°C Db IP64 X / Ex h IIIB T200°C Db X
Ta ambient temperature	-20 °C ≤ Ta ≤ +60 °C
Time t _A	170 sek
Operating mode	S1
PTC DIN 44082	M 130

DZR 30/4 B Ex t

EC type examination certificate	TÜV-A 19 ATEX0103 X, IECEx EPS 19.0019X
Temperature class	T200°C
Temperature class of insulating materials Th. Cl.	155 (F)
Packing unit	1 piece
Range	C
GTIN (EAN)	4012799867241

Characteristic curve

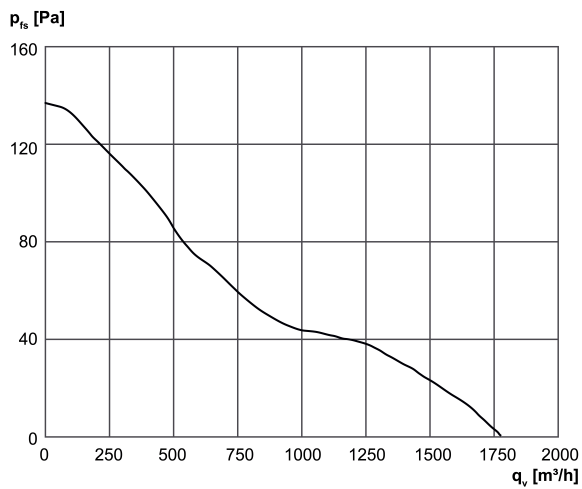

DZR 30/4 B Ex t

Dimensioned drawing [mm]

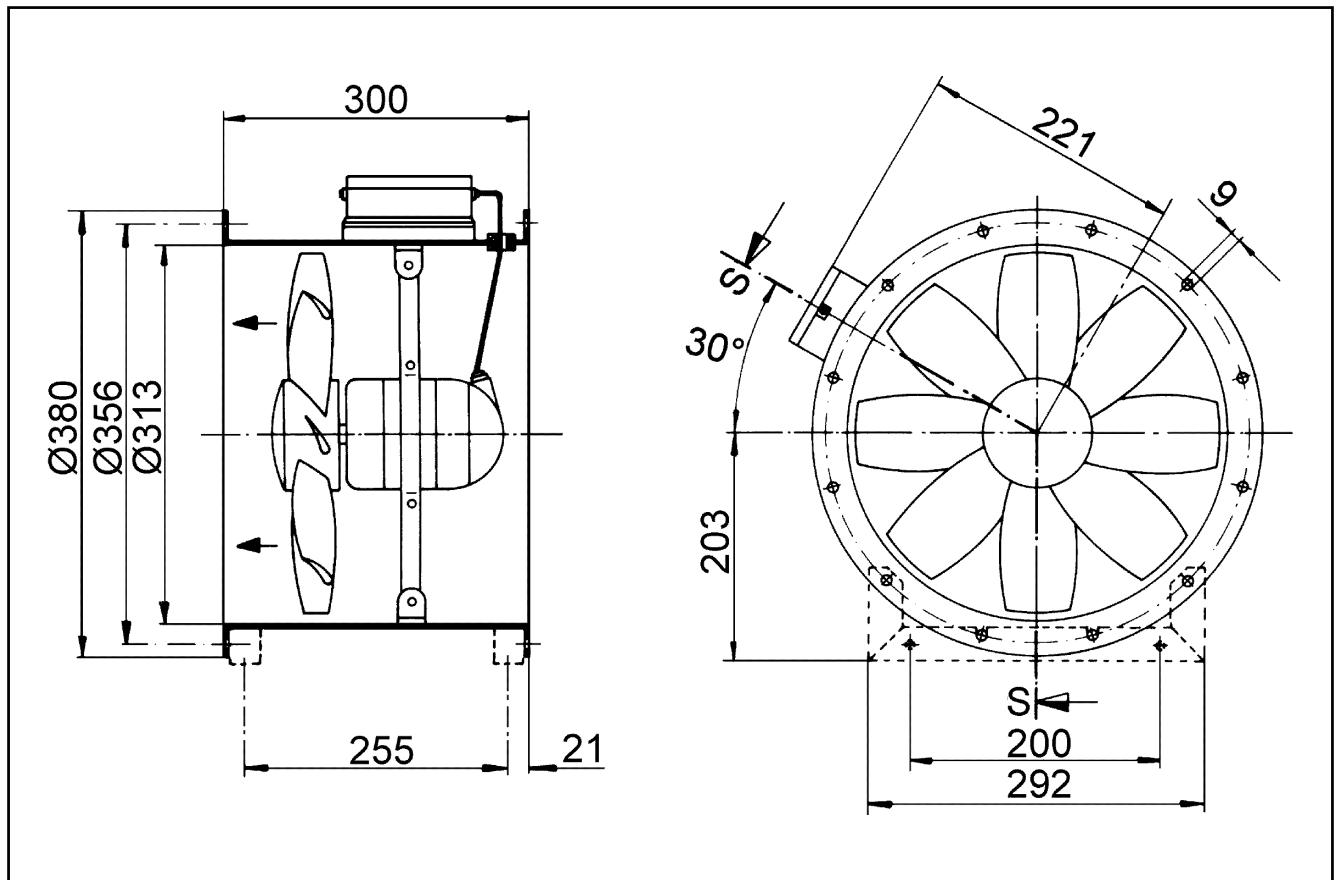

Number of flange holes: 8