

DZR 30/2 B Ex e



Short description

Axial duct fan, DN300, three-phase AC, explosion-proof, medium: gas

Application examples

Environment with explosion hazard (zone 1 and 2), Workshop, Storage facility, Laboratory, Workplace air extraction system

Article number 0086.0705

Technical data

Air flow volume	3.410 m ³ /h
Rotating speed	2.910 1/min
Impeller type	axial
Speed controllable	✓
Reversing capacity	✓
Type of voltage	Three-phase AC
Rated voltage	400 V
Frequency	50 Hz
Nominal output	240 W
cosφ	0,73
I _{nom}	0,46 A
I _{max} at U _{Nominal}	0,89 A
Degree of protection	IP 64
Insulation class	F
Installation position	vertical / horizontal
Material	Sheet steel, galvanised
Housing material	Sheet steel, galvanised
Colour	galvanised
Weight	12,3 kg
Weight including packaging	13,22 kg
Nominal size	300 mm
Width	424 mm
Height	424 mm
Depth	300 mm
Width with packaging	425 mm
Height with packaging	430 mm
Depth with packaging	330 mm
EX designation in accordance with the ATEX Directive	Ex II 2 G
EX designation in accordance with standard	Ex eb IIB + H ₂ T3 Gb / Ex h IIB + H ₂ T3 Gb

DZR 30/2 B Ex e

Ta ambient temperature	-20 °C ≤ Ta ≤ +60 °C
I _A /I _N	8,5
Time t _A	85 sek
Operating mode	S1
PTC DIN 44082	M 100
EC type examination certificate	TÜV-A 19 ATEX0103 X, IECEx EPS 19.0019X
Temperature class	T3
Temperature class of insulating materials Th. Cl.	155 (F)
Packing unit	1 piece
Range	C
GTIN (EAN)	4012799867050

Sound power level in octave range

	63 Hz	125 Hz	250 Hz	500 Hz	1 kHz	2 kHz	4 kHz	8 kHz	Total
L _{WA5, high} (dB(A))	-	-	-	-	-	-	-	-	85

L_{WA5}= free inlet sound power level in dB.

Characteristic curve

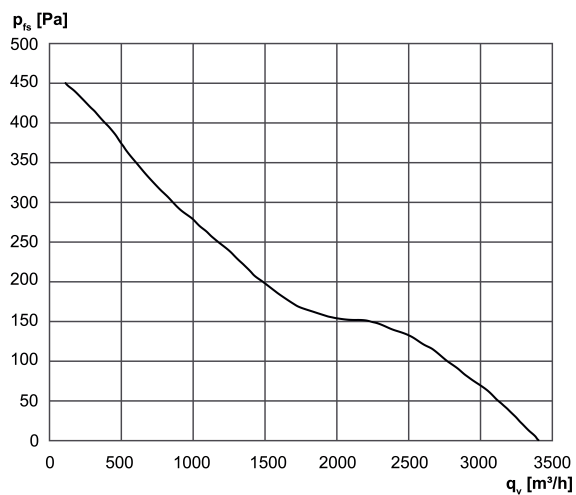

DZR 30/2 B Ex e

Dimensioned drawing [mm]

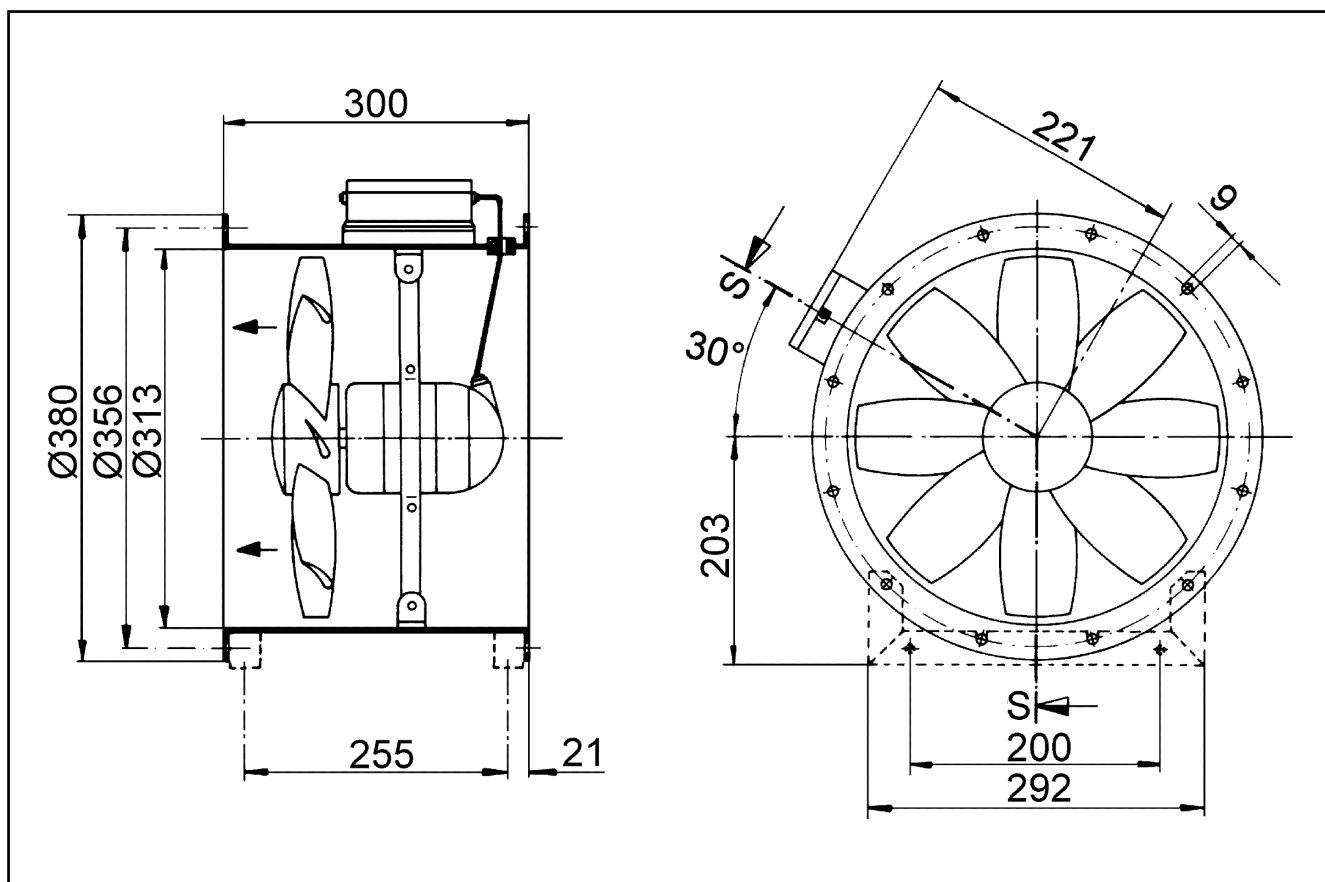

Number of flange holes: 8