

DZR 25/2 B



Short description

Axial duct fan, DN 250, three-phase AC

Application examples

Machine extraction unit, Showroom, Foreman's office, Workshop, Production site

Article number 0086.0022

Technical data

Air flow volume	2.190 m ³ /h
Air volume _{nom}	1.580 m ³ /h (in opt. efficiency)
Pressure p _{fs, nom}	137 Pa (in opt. efficiency)
Rotating speed n _{nom}	2.280 1/min (in opt. efficiency)
Rotating speed	2.913 1/min
Impeller type	axial
Speed controllable	✓
Reversing capacity	✓
Type of voltage	Three-phase AC
Rated voltage	400 V
Frequency	50 Hz
Nominal output	175 W (in opt. efficiency)
I _{nom}	0,35 A (in opt. efficiency)
I _{max}	0,4 A
Degree of protection	IP 55
Insulation class	B
Pole-changeable	–
Mains cable	7 x 1,5 mm ²
Installation position	horizontal / vertical
Material	Sheet steel, galvanised
Colour	Silver
Weight	8,26 kg
Weight including packaging	9,1 kg
Nominal size	250 mm
Width	304 mm
Height	372 mm
Depth	300 mm
Width with packaging	420 mm
Height with packaging	440 mm

DZR 25/2 B

Depth with packaging	330 mm
Airstream temperature at nominal current	60 °C
Airstream temperature at I _{Max}	60 °C
Packing unit	1 piece
Range	C
GTIN (EAN)	4012799860228

Technical data according to ErP in Best Efficiency Point (BEP)

Total efficiency η	46,9 %
Measurement category	D
Efficiency category	total
Efficiency level N	58,2
VSD necessary	No
Year of manufacture	see rating plate
Manufacturer's name / official registration number / manufacturer's place of establishment	Maico Elektroapparate-Fabrik GmbH / Freiburg registration court, HRB 601233 / Villingen-Schwenningen
Art. No.	0086.0022
P _{BEP} / Air volume _{BEP} / P _{fs, BEP}	0,163 kW / 1.810 m ³ /h
n_{BEP}	2.890 1/min
Specific ratio	≈ 1
Information about dismantling and disposal	see mounting instructions
Information about installation, operation and repairs	see mounting instructions
Objects used to measure efficiency which are not described by the measurement category	-
P _{f, BEP}	152 Pa
Sound power level _{L_{WA5}}	82 dB(A)

Sound power level in octave range

	63 Hz	125 Hz	250 Hz	500 Hz	1 kHz	2 kHz	4 kHz	8 kHz	Total
L_{WA2, S1} (dB(A))	-	-	-	-	-	-	-	-	53
L_{WA2, S2} (dB(A))	-	-	-	-	-	-	-	-	62
L_{WA2, S3} (dB(A))	-	-	-	-	-	-	-	-	66
L_{WA2, S4} (dB(A))	-	-	-	-	-	-	-	-	76
L_{WA2, S5} (dB(A))	35	46	52	62	67	64	61	54	70
L_{WA5, S1} (dB(A))	-	-	-	-	-	-	-	-	64

DZR 25/2 B

	63 Hz	125 Hz	250 Hz	500 Hz	1 kHz	2 kHz	4 kHz	8 kHz	Total
L_{WA5, S2} (dB(A))	-	-	-	-	-	-	-	-	76
L_{WA5, S3} (dB(A))	-	-	-	-	-	-	-	-	78
L_{WA5, S4} (dB(A))	-	-	-	-	-	-	-	-	83
L_{WA5, S5} (dB(A))	36	48	66	78	77	76	71	61	82
L_{WA6, S1} (dB(A))	-	-	-	-	-	-	-	-	69
L_{WA6, S2} (dB(A))	-	-	-	-	-	-	-	-	79
L_{WA6, S3} (dB(A))	-	-	-	-	-	-	-	-	82
L_{WA6, S4} (dB(A))	-	-	-	-	-	-	-	-	85
L_{WA6, S5} (dB(A))	48	52	69	81	81	80	76	71	86

L_{WA2}= housing sound power level in dB.
 L_{WA5}= free inlet sound power level in dB.
 L_{WA6}= free outlet sound power level in dB.

Characteristic curve

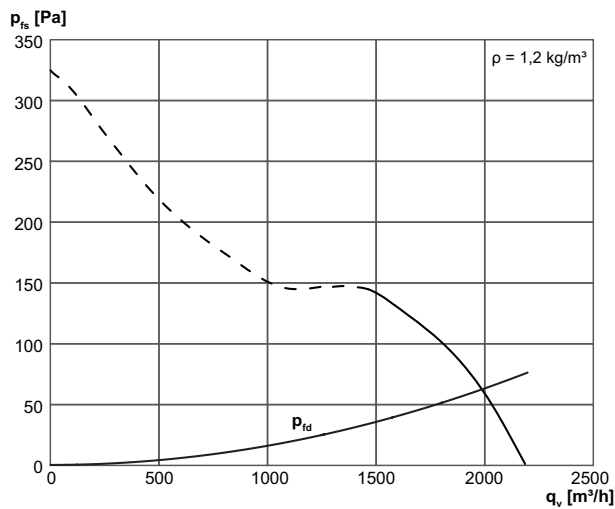

DZR 25/2 B

Dimensioned drawing [mm]

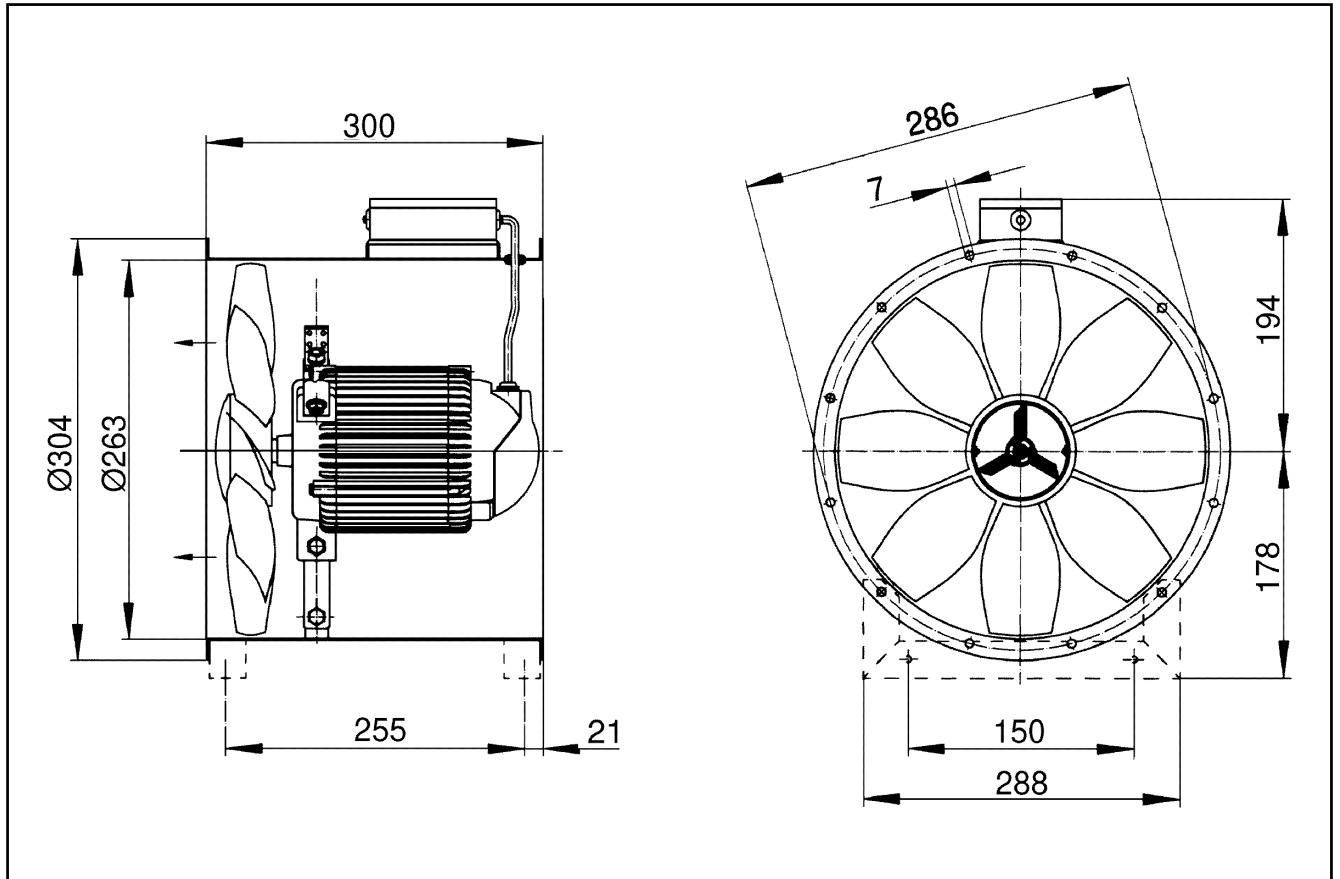

Number of flange holes: 6