



Acoustic cabinet fans, hermetic and self-cleaning, manufactured from galvanised sheet steel and internally lined with 25mm thickness of fireproof acoustic fiberglass insulation (M0), direct drive backward curved centrifugal impeller, dynamically balanced.

Direct supply brushless EC motor, high performance, low consumption, ball bearings, built-in thermal protector and able to work at temperatures from -20°C to +40°C:

- Single-phase version
230V±10% 50/60Hz, IP44.

- Three-phase version
400V±10% 50/60Hz, IP54.

Adjustable speed 100% by potentiometer located in the terminal box or by external control type REB-ECOWATT. Analogue input signal 0-10V to control the fan.

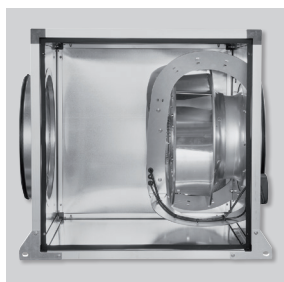

Backward curved centrifugal impellers

To prevent accumulation of dirtiness. Dynamically balanced.

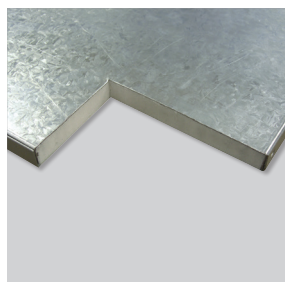

Low noise level

Internally lined with 25mm thickness of fireproof acoustic fiberglass insulation (M0) reducing the noise level significantly.



Robustness

Quality finished aluminium profiles and plastic corners providing a great robustness.



IP55 external terminal box

To facilitate electric.

Alternative fitting

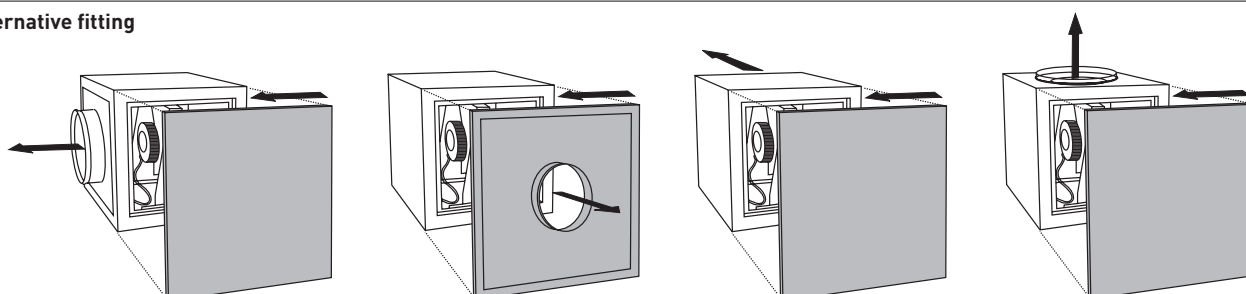

ACOUSTIC CABINET FANS SELF-CLEANING CVAB/T-N ECOWATT series



TECHNICAL CHARACTERISTICS

Before installation check that the product electrical characteristics listed on the data plate label (voltage, power, frequency, etc.) match those of the intended electrical supply.

SINGLE-PHASE 230V±10% 50/60HZ

Model	Control voltage	Speed (r.p.m.)	Maximum absorbed power (W)	Maximum absorbed current (A)	Maximum airflow (m ³ /h)	Sound pressure level (dB(A)) a 1,5 m*			Weight (kg)
						Inlet	Outlet	Breat-Out	
CVAB-1400/250N ECOWATT	10	2650	200	1,3	1.318	59	63	47	25
	8	2273	129	0,9	1.126	56	60	44	
	6	1787	67	0,5	866	51	55	39	
	4	1270	29	0,3	638	43	47	31	
CVAB-2000/315N ECOWATT	10	1899	210	0,9	2.103	56	61	49	26
	8	1671	148	0,7	1.861	53	58	46	
	6	1336	81	0,4	1.471	48	53	41	
	4	1019	42	0,3	1.096	42	47	35	
CVAB-3000/355N ECOWATT	10	1799	347	1,4	3.049	61	65	50	41
	8	1592	251	1,1	2.728	58	62	47	
	6	1277	131	0,6	2.212	53	57	42	
	4	973	64	0,3	1.679	47	51	37	
CVAB-4000/400N ECOWATT	10	1644	497	2,1	4.116	61	63	52	42
	8	1516	394	1,6	3.645	59	61	50	
	6	1233	216	0,9	2.964	54	56	46	
	4	944	102	0,5	2.301	48	51	40	
CVAB-6000/450 N ECOWATT	10	1459	1021	4,17	6.391	64	65	55	49
	8	1285	711	2,94	5.061	62	63	51	
	6	1060	407	1,68	4.594	58	58	48	
	4	833	208	0,87	3.595	53	53	42	

*Middle point of the curve

THREE-PHASE 400V±10% 50/60HZ

Model	Control voltage	Speed (r.p.m.)	Maximum absorbed power (W)	Maximum absorbed current (A)	Maximum airflow (m ³ /h)	Sound pressure level (dB(A)) a 1,5 m*			Weight (kg)
						Inlet	Outlet	Breat-Out	
CVAT-9000/500 N ECOWATT	10	1370	1235	2,1	7620	63	63	51	61
	8	1220	878	1,5	6700	61	61	48	
	6	1010	508	0,9	5510	57	56	44	
	4	800	274	0,6	4440	52	52	39	
CVAT-12000/560 N ECOWATT	10	1380	2653	3,9	11830	68	69	53	85
	8	1150	1555	2,4	9710	64	65	49	
	6	920	809	1,4	7690	59	60	44	
	4	680	361	0,7	5740	53	54	37	

*Middle point of the curve

DIMENSIONS (MM)

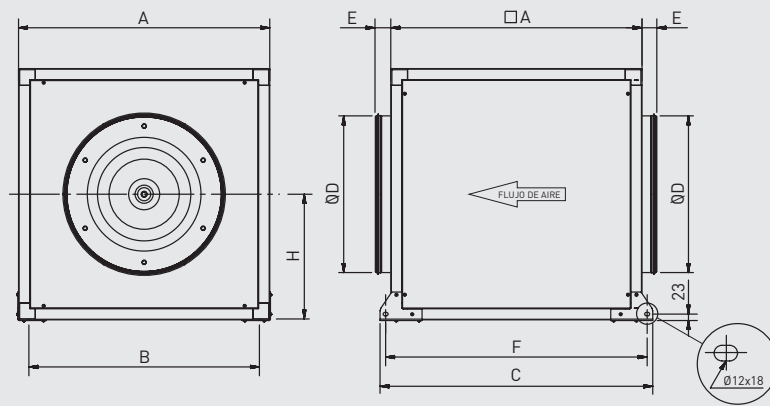

Model CVAB-N ECOWATT	A	B	C	D	E	F	H
1400/250 N	500	457	574	250	58	534	250
2000/315 N	500	457	574	315	58	534	250
3000/355 N	650	607	724	355	58	684	325
4000/400 N	650	607	724	400	58	684	325
6000/450 N	750	707	824	450	58	784	375
9000/500 N	800	757	874	500	58	834	400
12000/560 N	900	826	977	560	58	937	450

PERFORMANCE CURVES - ACOUSTIC CHARACTERISTICS

- q_v = Airflow in m^3/h .
- p_{sf} = Static pressure in Pa.
- P: Input power in W.
- SFP: Specific fan power in $W/m^3/s$ (blue curves).
- Performance data in accordance with ISO 5801 and AMCA 210-99 Standards.

CVAB-1400/250N ECOWATT

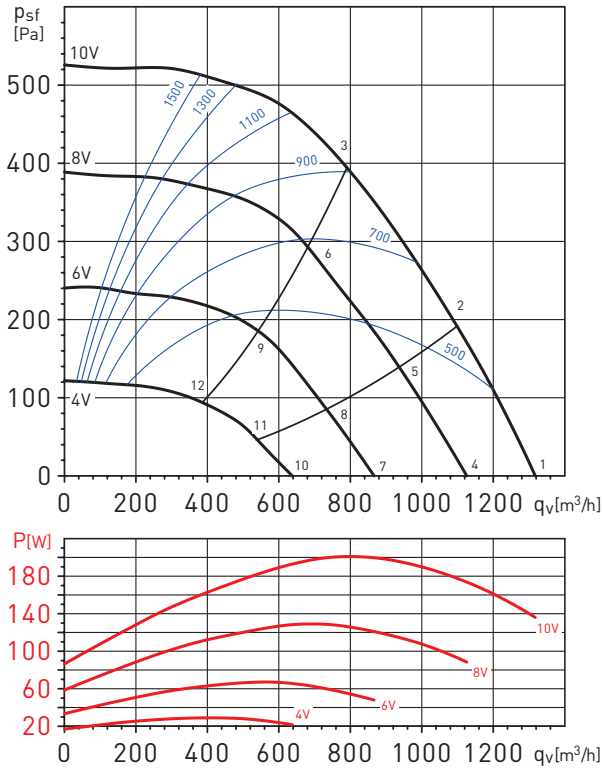

Sound power level spectrums in dB(A)

Working point		63	125	250	500	1.000	2.000	4.000	8.000	LwA
1	Inlet	44	54	71	74	76	69	66	65	80
	Outlet	44	53	61	59	71	71	68	65	76
	Break-Out	44	51	52	55	58	56	55	54	63
2	Inlet	40	53	70	72	73	67	65	62	77
	Outlet	42	51	60	57	69	69	66	62	73
	Break-Out	40	50	51	53	55	54	54	51	61
3	Inlet	37	51	68	69	70	65	64	61	75
	Outlet	40	47	56	54	65	66	65	60	71
	Break-Out	37	48	49	50	52	52	53	50	59
4	Inlet	41	51	68	71	73	66	63	62	76
	Outlet	41	50	58	56	68	68	65	62	72
	Break-Out	41	48	49	52	55	53	52	51	60
5	Inlet	37	50	67	69	70	64	62	59	74
	Outlet	39	48	57	54	66	66	63	59	70
	Break-Out	37	47	48	50	52	51	51	48	58
6	Inlet	34	48	65	66	67	62	61	58	72
	Outlet	37	44	53	51	62	63	62	57	67
	Break-Out	34	45	46	47	49	49	50	47	56
7	Inlet	32	42	59	62	64	57	54	53	68
	Outlet	35	44	52	50	62	62	59	56	67
	Break-Out	32	39	40	43	46	44	43	42	52
8	Inlet	31	44	61	63	64	58	56	53	69
	Outlet	33	42	51	48	60	60	57	53	65
	Break-Out	31	41	42	44	46	45	45	42	53
9	Inlet	28	42	59	60	61	56	55	52	66
	Outlet	31	38	47	45	56	57	56	51	62
	Break-Out	28	39	40	41	43	43	44	41	51
10	Inlet	28	38	55	58	60	53	50	49	64
	Outlet	28	37	45	43	55	55	52	49	60
	Break-Out	28	35	36	39	42	40	39	38	48
11	Inlet	24	37	54	56	57	51	49	46	62
	Outlet	26	35	44	41	53	53	50	46	58
	Break-Out	24	34	35	37	39	38	38	35	45
12	Inlet	21	35	52	53	54	49	48	45	59
	Outlet	24	31	40	38	49	50	49	44	55
	Break-Out	21	32	33	34	36	36	37	34	43

PERFORMANCE CURVES - ACOUSTIC CHARACTERISTICS

- q_v = Airflow in m^3/h .
- p_{sf} = Static pressure in Pa.
- P: Input power in W.
- SFP: Specific fan power in $W/m^3/s$ (blue curves).
- Performance data in accordance with ISO 5801 and AMCA 210-99 Standards.

CVAB-2000/315N ECOWATT

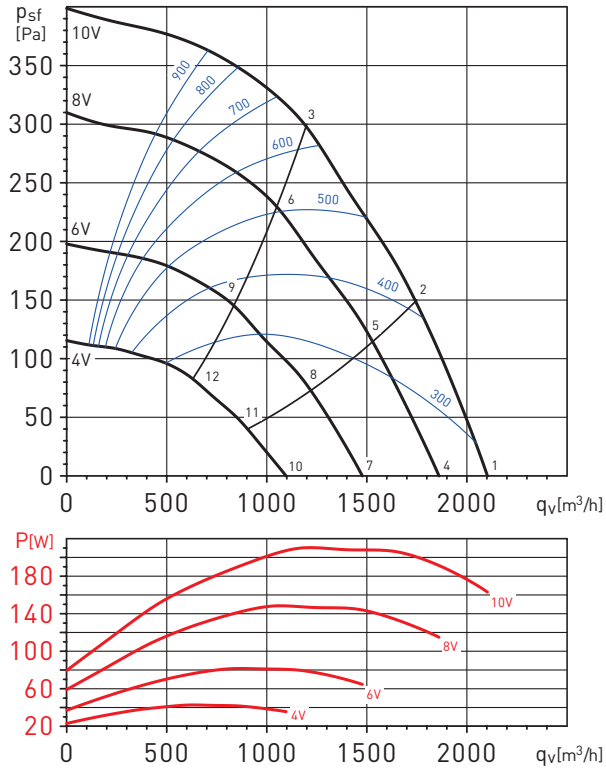

Sound power level spectrums in dB(A)

Working point	63	125	250	500	1.000	2.000	4.000	8.000	LwA
1	Inlet	41	55	74	68	67	65	57	76
	Outlet	41	53	65	59	67	66	64	72
	Break-Out	41	49	58	56	59	57	56	65
2	Inlet	39	51	73	68	65	64	61	75
	Outlet	39	51	63	58	65	65	60	70
	Break-Out	39	45	57	56	57	56	52	63
3	Inlet	37	49	68	68	65	62	59	73
	Outlet	36	47	58	56	65	64	60	69
	Break-Out	37	43	52	56	57	54	50	62
4	Inlet	38	52	71	65	64	62	62	74
	Outlet	38	50	62	56	64	63	61	69
	Break-Out	38	46	55	53	56	54	53	62
5	Inlet	36	48	70	65	62	61	58	72
	Outlet	36	48	60	55	62	62	57	67
	Break-Out	36	42	54	53	54	53	49	60
6	Inlet	34	46	65	65	62	59	56	70
	Outlet	33	44	55	53	62	61	57	66
	Break-Out	34	40	49	53	54	51	47	59
7	Inlet	31	45	64	58	57	55	55	66
	Outlet	33	45	57	51	59	58	56	64
	Break-Out	31	39	48	46	49	47	46	54
8	Inlet	31	43	65	60	57	56	53	68
	Outlet	31	43	55	50	57	57	52	62
	Break-Out	31	37	49	48	49	48	44	55
9	Inlet	29	41	60	60	57	54	51	65
	Outlet	28	39	50	48	57	56	52	61
	Break-Out	29	35	44	48	49	46	42	54
10	Inlet	27	41	60	54	53	51	51	63
	Outlet	27	39	51	45	53	52	50	59
	Break-Out	27	35	44	42	45	43	42	51
11	Inlet	25	37	59	54	51	50	47	62
	Outlet	25	37	49	44	51	51	46	57
	Break-Out	25	31	43	42	43	42	38	50
12	Inlet	23	35	54	54	51	48	45	59
	Outlet	22	33	44	42	51	50	46	55
	Break-Out	23	29	38	42	43	40	36	48

PERFORMANCE CURVES - ACOUSTIC CHARACTERISTICS

- q_v = Airflow in m^3/h .
- p_{sf} = Static pressure in Pa.
- P: Input power in W.
- SFP: Specific fan power in $W/m^3/s$ (blue curves).
- Performance data in accordance with ISO 5801 and AMCA 210-99 Standards.

CVAB-3000/355N ECOWATT

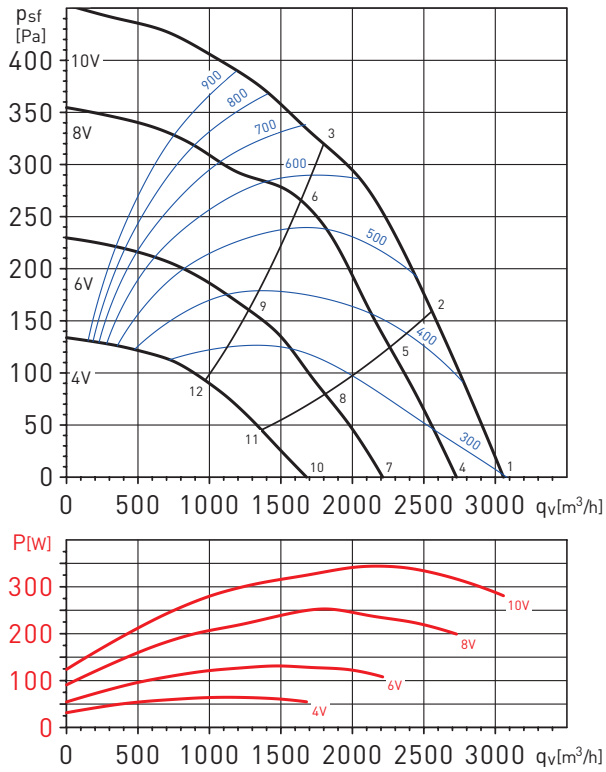

Sound power level spectrums in dB(A)

Working point	63	125	250	500	1.000	2.000	4.000	8.000	LwA	
1	Inlet	49	62	75	76	73	71	70	65	81
	Outlet	52	54	68	66	73	71	67	59	77
	Break-Out	44	52	60	57	58	58	59	53	66
2	Inlet	47	60	73	75	71	70	68	61	79
	Outlet	50	52	66	64	72	69	64	56	75
	Break-Out	42	50	58	56	56	57	57	49	64
3	Inlet	43	60	71	74	70	69	64	57	78
	Outlet	51	50	63	64	71	67	62	54	74
	Break-Out	38	50	56	55	55	56	53	45	62
4	Inlet	46	59	72	73	70	68	67	62	78
	Outlet	49	51	65	63	70	68	64	56	74
	Break-Out	41	49	57	54	55	55	56	50	63
5	Inlet	44	57	70	72	68	67	65	58	77
	Outlet	47	49	63	61	69	66	61	53	73
	Break-Out	39	47	55	53	53	54	54	46	62
6	Inlet	40	57	68	71	67	66	61	54	75
	Outlet	48	47	60	61	68	64	59	51	71
	Break-Out	35	47	53	52	52	53	50	42	60
7	Inlet	39	52	65	66	63	61	60	55	71
	Outlet	45	47	61	59	66	64	60	52	69
	Break-Out	34	42	50	47	48	48	49	43	56
8	Inlet	40	53	66	68	64	63	61	54	72
	Outlet	43	45	59	57	65	62	57	49	68
	Break-Out	35	43	51	49	49	50	50	42	57
9	Inlet	36	53	64	67	63	62	57	50	70
	Outlet	44	43	56	57	64	60	55	47	66
	Break-Out	31	43	49	48	48	49	46	38	55
10	Inlet	36	49	62	63	60	58	57	52	67
	Outlet	39	41	55	53	60	58	54	46	64
	Break-Out	31	39	47	44	45	45	46	40	53
11	Inlet	34	47	60	62	58	57	55	48	66
	Outlet	37	39	53	51	59	56	51	43	62
	Break-Out	29	37	45	43	43	44	44	36	51
12	Inlet	30	47	58	61	57	56	51	44	64
	Outlet	38	37	50	51	58	54	49	41	60
	Break-Out	25	37	43	42	42	43	40	32	49

PERFORMANCE CURVES - ACOUSTIC CHARACTERISTICS

- q_v = Airflow in m^3/h .
- p_{sf} = Static pressure in Pa.
- P: Input power in W.
- SFP: Specific fan power in $W/m^3/s$ (blue curves).
- Performance data in accordance with ISO 5801 and AMCA 210-99 Standards.

CVAB-4000/400N ECOWATT

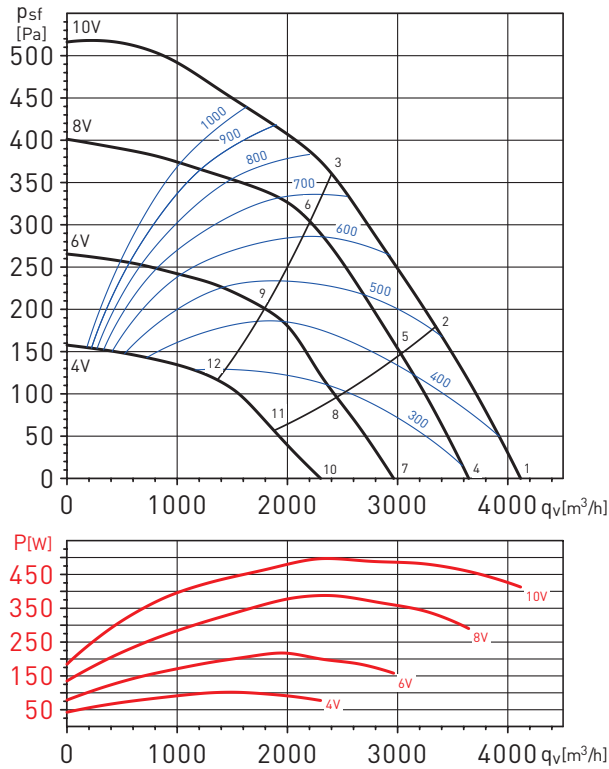

Sound power level spectrums in dB(A)

Working point		63	125	250	500	1.000	2.000	4.000	8.000	LwA
1	Inlet	49	64	73	74	70	69	66	61	79
	Outlet	51	59	65	66	75	72	68	60	78
	Break-Out	49	54	60	55	65	60	60	56	69
2	Inlet	47	63	73	72	68	66	63	56	77
	Outlet	49	56	60	64	72	69	64	56	75
	Break-Out	47	53	60	53	63	57	57	51	67
3	Inlet	42	62	72	71	67	65	62	55	76
	Outlet	48	55	59	64	73	69	65	59	76
	Break-Out	42	52	59	52	62	56	56	50	66
4	Inlet	47	62	71	72	68	67	64	59	77
	Outlet	49	57	63	64	73	70	66	58	76
	Break-Out	47	52	58	53	63	58	58	54	67
5	Inlet	45	61	71	70	66	64	61	54	75
	Outlet	47	54	58	62	70	67	62	54	73
	Break-Out	45	51	58	51	61	55	55	49	65
6	Inlet	40	60	70	69	65	63	60	53	74
	Outlet	46	53	57	62	71	67	63	57	74
	Break-Out	40	50	57	50	60	54	54	48	64
7	Inlet	41	56	65	66	62	61	58	53	70
	Outlet	45	53	59	60	69	66	62	54	72
	Break-Out	41	46	52	47	57	52	52	48	61
8	Inlet	41	57	67	66	62	60	57	50	71
	Outlet	43	50	54	58	66	63	58	50	69
	Break-Out	41	47	54	47	57	51	51	45	60
9	Inlet	36	56	66	65	61	59	56	49	70
	Outlet	42	49	53	58	67	63	59	53	69
	Break-Out	36	46	53	46	56	50	50	44	59
10	Inlet	37	52	61	62	58	57	54	49	66
	Outlet	39	47	53	54	63	60	56	48	66
	Break-Out	37	42	48	43	53	48	48	44	57
11	Inlet	35	51	61	60	56	54	51	44	65
	Outlet	37	44	48	52	60	57	52	44	63
	Break-Out	35	41	48	41	51	45	45	39	55
12	Inlet	30	50	60	59	55	53	50	43	64
	Outlet	36	43	47	52	61	57	53	47	63
	Break-Out	30	40	47	40	50	44	44	38	54

PERFORMANCE CURVES - ACOUSTIC CHARACTERISTICS

- q_v = Airflow in m^3/h .
- p_{sf} = Static pressure in Pa.
- P: Input power in W.
- SFP: Specific fan power in $W/m^3/s$ (blue curves).
- Performance data in accordance with ISO 5801 and AMCA 210-99 Standards.

CVAB-6000/450N ECOWATT

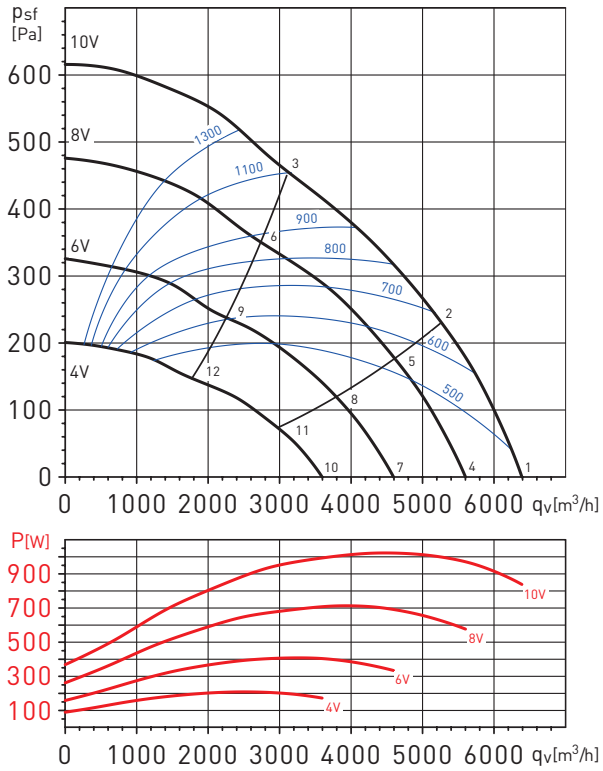

Sound power level spectrums in dB(A)

Working point		63	125	250	500	1000	2000	4000	8000	LwA
1	Inlet	61	75	73	77	74	73	68	60	82
	Outlet	62	65	66	71	78	76	69	61	81
	Break-Out	56	65	64	61	61	66	62	55	71
2	Inlet	56	72	71	73	72	71	67	60	79
	Outlet	59	64	64	67	75	74	69	60	79
	Break-Out	51	62	62	57	59	64	61	55	69
3	Inlet	58	72	70	74	71	71	65	57	79
	Outlet	60	63	63	68	75	73	67	58	78
	Break-Out	53	62	61	58	58	63	59	52	69
4	Inlet	54	69	68	71	69	69	64	57	77
	Outlet	56	62	61	65	73	71	66	57	76
	Break-Out	49	59	59	55	56	61	59	52	67
5	Inlet	49	66	66	68	68	67	64	59	75
	Outlet	53	58	60	63	71	70	69	57	75
	Break-Out	43	56	57	52	55	60	59	55	65
6	Inlet	54	68	66	70	67	66	61	53	75
	Outlet	55	58	59	64	71	69	62	54	74
	Break-Out	49	58	57	54	54	59	55	48	64
7	Inlet	49	65	64	66	65	64	60	53	72
	Outlet	52	57	57	60	68	67	62	53	72
	Break-Out	44	55	55	50	52	57	54	48	62
8	Inlet	49	65	64	66	65	64	60	53	72
	Outlet	52	57	57	60	68	67	62	53	72
	Break-Out	44	55	55	50	52	57	54	48	62
9	Inlet	44	62	62	64	64	63	60	55	70
	Outlet	48	54	56	58	66	66	65	53	71
	Break-Out	39	52	52	48	51	56	54	50	61
10	Inlet	48	62	61	64	62	61	55	47	69
	Outlet	50	53	54	58	65	63	57	49	69
	Break-Out	43	52	52	48	48	53	50	42	59
11	Inlet	44	60	58	61	59	59	55	48	67
	Outlet	47	52	52	55	63	61	57	48	67
	Break-Out	39	50	49	45	46	51	49	43	57
12	Inlet	39	57	56	59	59	58	54	50	65
	Outlet	43	49	50	53	61	60	59	48	66
	Break-Out	34	46	47	43	45	50	49	45	56

PERFORMANCE CURVES - ACOUSTIC CHARACTERISTICS

- q_v = Airflow in m^3/h .
- p_{sf} = Static pressure in Pa.
- P: Input power in W.
- SFP: Specific fan power in $W/m^3/s$ (blue curves).
- Performance data in accordance with ISO 5801 and AMCA 210-99 Standards.

CVAT-9000/500 N ECOWATT

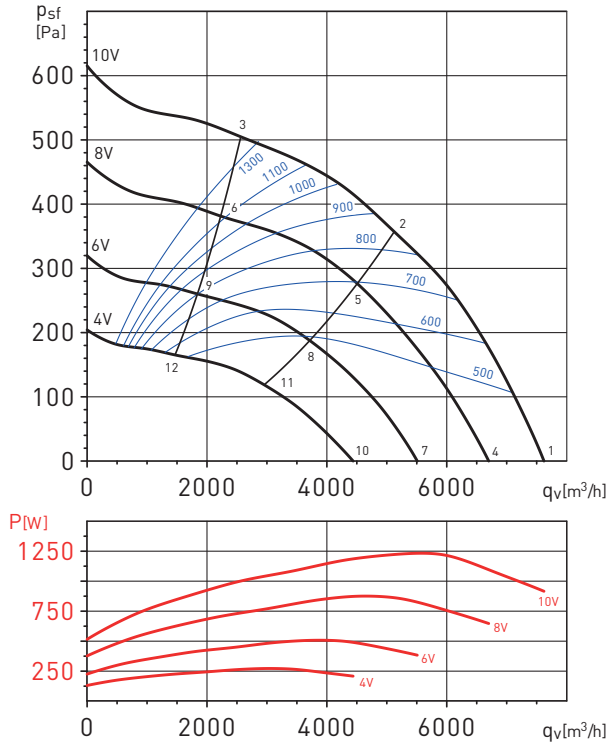

Sound power level spectrums in dB(A)

Working point		63	125	250	500	1.000	2.000	4.000	8.000	LwA
1	Inlet	53	74	72	77	73	72	72	68	82
	Outlet	51	76	68	73	76	75	73	66	82
	Break-Out	44	64	65	61	56	54	53	46	69
2	Inlet	52	72	68	72	69	68	69	59	78
	Outlet	46	71	64	69	72	71	69	60	78
	Break-Out	42	61	61	56	52	50	50	37	65
3	Inlet	53	71	70	72	68	69	67	58	78
	Outlet	50	67	64	67	71	71	68	60	77
	Break-Out	44	61	63	56	52	51	48	36	66
4	Inlet	50	72	69	75	70	70	70	66	79
	Outlet	48	73	66	70	73	72	70	64	79
	Break-Out	41	61	62	58	54	51	51	44	66
5	Inlet	49	69	66	70	66	66	66	57	75
	Outlet	43	68	62	66	69	68	67	57	75
	Break-Out	40	59	59	53	50	48	47	35	63
6	Inlet	50	69	68	70	66	66	65	56	75
	Outlet	47	65	62	64	68	68	66	57	74
	Break-Out	41	58	61	53	49	48	46	34	64
7	Inlet	46	67	65	71	66	65	66	62	75
	Outlet	44	69	62	66	69	68	66	60	75
	Break-Out	37	57	58	54	50	47	47	40	62
8	Inlet	45	65	62	66	62	62	62	53	71
	Outlet	39	64	57	62	65	64	62	53	71
	Break-Out	36	55	55	49	46	44	43	31	59
9	Inlet	46	64	64	66	62	62	60	51	71
	Outlet	43	60	57	60	64	64	62	53	70
	Break-Out	37	54	57	49	45	44	41	29	59
10	Inlet	41	63	60	66	61	61	61	57	70
	Outlet	39	64	57	61	64	63	61	55	70
	Break-Out	32	52	53	49	45	42	42	35	57
11	Inlet	40	60	57	61	57	57	57	48	66
	Outlet	34	59	53	57	60	59	58	48	66
	Break-Out	31	50	50	44	41	39	38	26	54
12	Inlet	41	60	59	61	57	57	56	47	66
	Outlet	38	56	53	55	59	59	57	48	65
	Break-Out	32	49	52	44	40	39	37	25	55

PERFORMANCE CURVES - ACOUSTIC CHARACTERISTICS

- q_v = Airflow in m^3/h .
- p_{sf} = Static pressure in Pa.
- P: Input power in W.
- SFP: Specific fan power in $W/m^3/s$ (blue curves).
- Performance data in accordance with ISO 5801 and AMCA 210-99 Standards.

CVAT-12000/560 N ECOWATT

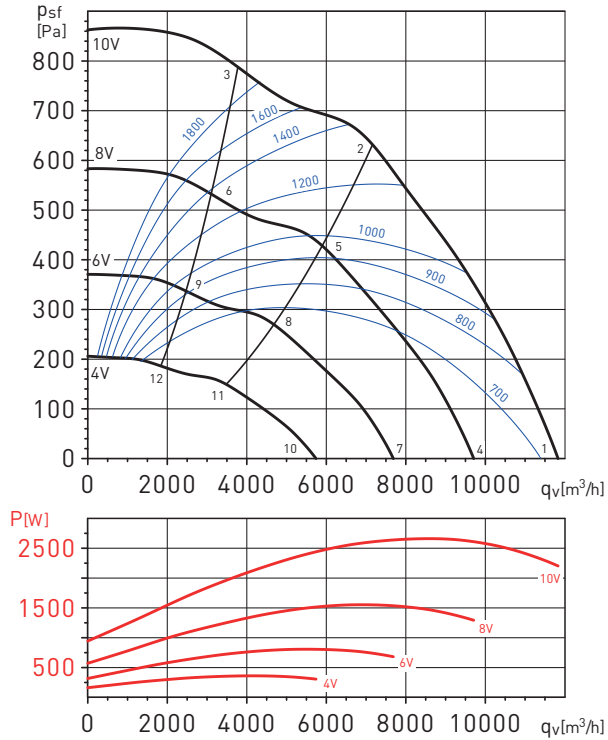

Sound power level spectrums in dB(A)

Working point		63	125	250	500	1.000	2.000	4.000	8.000	LwA
1	Inlet	61	75	78	81	80	79	77	71	87
	Outlet	62	68	72	80	84	81	77	70	88
	Break-Out	60	63	69	61	61	61	60	48	72
2	Inlet	54	70	73	75	76	77	75	70	83
	Outlet	50	59	66	74	78	79	76	70	84
	Break-Out	53	58	64	54	57	59	58	47	67
3	Inlet	55	75	72	73	74	77	75	71	83
	Outlet	51	61	64	72	76	79	76	70	83
	Break-Out	54	63	63	53	55	59	58	47	68
4	Inlet	57	71	74	77	76	75	73	67	83
	Outlet	58	64	68	76	80	77	73	66	84
	Break-Out	56	59	65	57	57	57	56	44	68
5	Inlet	50	66	69	71	72	73	71	66	79
	Outlet	46	55	62	70	74	75	72	66	80
	Break-Out	49	54	60	50	53	55	54	43	63
6	Inlet	51	71	68	69	70	73	71	67	79
	Outlet	47	57	60	68	72	75	72	66	79
	Break-Out	50	59	59	49	51	55	54	43	64
7	Inlet	52	66	69	72	71	70	68	62	78
	Outlet	53	59	63	71	75	72	68	61	79
	Break-Out	51	54	60	52	52	52	51	39	63
8	Inlet	45	61	64	66	67	68	66	61	74
	Outlet	41	50	57	65	69	70	67	61	75
	Break-Out	44	49	55	45	48	50	49	38	58
9	Inlet	46	66	63	64	65	68	66	62	74
	Outlet	42	52	55	63	67	70	67	61	74
	Break-Out	45	54	54	44	46	50	49	38	59
10	Inlet	45	59	63	66	65	64	61	55	71
	Outlet	47	53	56	65	69	66	62	55	72
	Break-Out	44	48	54	45	46	46	45	32	57
11	Inlet	39	54	57	59	60	62	60	55	67
	Outlet	35	44	51	58	63	64	61	54	68
	Break-Out	38	43	48	39	41	44	43	31	52
12	Inlet	39	60	57	58	58	61	59	55	67
	Outlet	36	46	49	57	61	64	60	54	67
	Break-Out	38	48	48	37	39	43	43	32	53

MOUNTING ACCESSORIES



MBE
Electric heaters.



MBW
Hot water coil.



MFL-G4
Filtration boxes.



SIL
Sound attenuators.



ACOPEL F400 N
Circular flexible connector.



CRC
Circular reducers.



APC
Discharge protection guards for direct connection to the inlet-outlet flange



CTI CVA/CHAT
Outdoor cover For outdoor installations.



KSE
Anti-vibration mounts.

Model CVAB-N ECOWATT	Model APC	Model CTI CVA/CHAT
1400/250N	APC-250	CTI CVA-N 250/315
2000/315N	APC-315	CTI CVA-N 250/315
3000/355N	APC-355	CTI CVA-355/400 CHAT-400/450
4000/400N	APC-400	CTI CVA-355/400 CHAT-400/450
6000/450N	APC-450	CTI CVA-N 450
9000/500N	APC-500	CTI CVA-500 CHAT-500
12000/560N	APC-560	CTI CVA-N 560

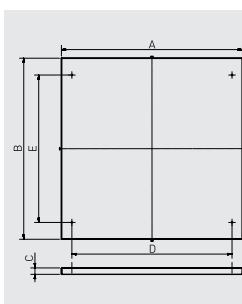

Model	A	B	C	D	E
CTI CVA-N 250/315	530	530	40	419	340
CTI CVA-355/400 CHAT-400/450	680	680	40	569	490
CTI CVA-N 450	780	780	40	669	590
CTI CVA-500 CHAT-500	830	830	40	719	640
CTI CVA-N 560	930	930	40	799	720
CTI CVA-N 630	1030	1030	40	900	820
CTI CVA-N 710	1130	1130	40	1000	920
CTI CHAT-N 800	1203	1203	40	1094	994

ELECTRICAL ACCESSORIES



AIRSENS-CO2
AIRSENS-VOC
AIRSENS-RH
IAQ intelligent sensor that incorporates an internal CO₂ or VOC or HR sensor.



CONTROL ECOWATT AC/DC
Control element for demand controlled ventilation systems.



CONTROL ECOWATT BASIC
Speed control and single-phase ON/OFF.



REB-ECOWATT
Speed controller.



SC02-AD
CO₂ and temperature sensor, with display.
SCHT-AD
CO₂, temperature and relative humidity sensor with display.



CPTA-S/CPTA-E
Presence detector.



TDP-S/TDP-D/TDP-PI
Pressure sensor.



REMP
Motorised damper.